

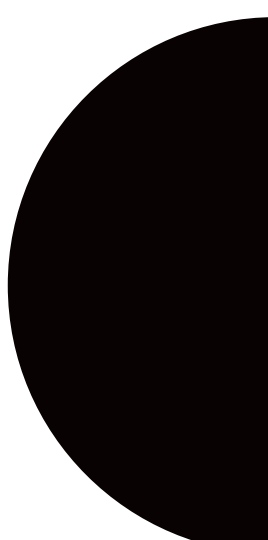

VERNICIATO GRIGIO
PAINTED GREY



VERNICIATO NERO
PAINTED BLACK



ZINCATO BIANCO
WHITE GALVANIZED



Da quarant'anni la CANZIAN produce ferramenta per infissi; nel 1974 per volontà del suo fondatore il Sig. Giorgio Canzian, grazie all'esperienza ventennale nel settore edile nasce la CANZIAN – FERRAMENTA PER INFISSI. Fin da subito si differenzia nelle idee originali ed innovative per migliorare la qualità e industrializzare i prodotti.

Negli anni vengono coinvolti i figli per garantire un seguito al suo impegno come imprenditore.

Sempre alla ricerca di nuove tecnologie, la CANZIAN, già nei primi anni investe in macchinari e continui ampliamenti della zona produttiva fino all'acquisto di un nuovo stabilimento nel 1999 che si affianca alla storica sede in Santa Lucia di Piave.

La CANZIAN comincia così una nuova fase di sviluppo proponendo nuovi prodotti nella ferramenta che escono dal normale contesto, sempre mantenendo le tradizioni locali ma agevolando i suoi clienti, mettendoli nella condizione di ridurre magazzini, spese e tempi di montaggio.

Trovando nel mercato un risposta positiva, i prodotti CANZIAN aumentano di gamma con investimenti da parte della proprietà per migliorare la qualità dei propri prodotti.

For forty years, CANZIAN produces ironware for external frames. In 1974, by the will of its founder, Mr Giorgio Canzian, thanks to twenty years of experience in the construction industry, CANZIAN – FERRAMENTA PER INFISSI was born. Right from the start it differs in original and innovative ideas to improve the quality and industrialized products.

Over the years, the sons got involved to ensure a follow-up to his commitment as entrepreneur.

Always looking for new technologies, Canzian, already in the early invests in machinery and continuous expansion of production area until the purchase of a new factory in 1999 that joins the historic home in Santa Lucia di Piave.

Canzian begins a new under development by offering new products in the ironware coming out of the normal context, while preserving the local traditions but facilitating its customers, putting them in a position to reduce warehouses, costs and installation time.



CANZIAN LA FORZA DELLA FERRAMENTA PER INFISSI





Nel 2009 la CANZIAN si stabilisce nella nuova ed attuale sede in Via Padania, 10-12 a San Vendemiano (TV).

Grazie alla sintonia creatasi tra i colleghi, la CANZIAN, é sempre alla ricerca di nuovi stimoli che abbracciano anche altri settori per incrementare il proprio catalogo articoli e far conoscere i suoi prodotti a nuovi mercati.

Finding a positive response in the market, the products CANZIAN increase of the range of property investments by improving the quality of its products. In 2009, CANZIAN is established in the new and current headquarters in Via Padania, 10/12 in San Vendemiano (TV).

Thanks to the harmony created between colleagues, CANZIAN, is always looking for new ideas that embrace other sectors to increase their catalog items and to introduce its products to new markets.



Italian quality
Italian technology
Italian production



7.....	SERIE TONDA – <i>SERIES TONDA</i>
11.....	BANDELLE A SNODO – <i>DOUBLE HINGES</i>
26.....	BANDELLE – <i>STRAIGHT HINGES</i>
37.....	BANDELLE A T – <i>T-SHAPED HINGES</i>
43.....	SERIE ALTERNATIVE – <i>ALTERNATIVE SERIES</i>
46.....	SERIE PVC – <i>SERIE PVC</i>
58.....	CERNIERE LEGNO – <i>HINGES FOR WOOD</i>
60.....	CARDINI – <i>PIVOTS</i>
67.....	CATENACCI - SPRANGHE – <i>LOCKING BOLT – BARS</i>
71.....	SPAGNOLETTE – <i>ESPAGNOLETTES</i>
74.....	ACCESSORI E COMPLEMENTI – <i>ACCESSORIES AND COMPLEMENTS</i>
83.....	INFO – <i>HELP</i>
85.....	CONTROLLO QUALITÀ – <i>QUALITY CONTROL</i>
86.....	CONDIZIONI GENERALI DI VENDITA – <i>GENERAL CONDITIONS OF SALE</i>

CANZIAN LA NOSTRA PRODUZIONE

ART. 108L |

BANDELLA DIRITTA LEGNO
STRAIGHT HINGE (WOOD)

CODICE Code	LUNGHEZZA Length	SPESSORE Thickness	Ø	Pcs	€
108LVN	65	38 x 3	10	24	
108LVG	65	38 x 3	10	24	
108LZB	65	38 x 3	10	24	

ABBINATA ART. 94 ◆ COMBINED ART. 94

ART. 108LSV |

BANDELLA DIRITTA LEGNO SVASATA
STRAIGHT HINGE , COUNTERSUNK HOLES (WOOD)

CODICE Code	LUNGHEZZA Length	SPESSORE Thickness	Ø	Pcs	€
108LSV VN	65	38 x 3	10	24	
108LSV VG	65	38 x 3	10	24	
108LSVZB	65	38 x 3	10	24	

ABBINATA ART. 94GR ◆ COMBINED ART. 94GR

ART. 108M |

BANDELLA DIRITTA MURO
STRAIGHT HINGE (WALL)

CODICE Code	LUNGHEZZA Length	SPESSORE Thickness	Ø	Pcs	€
108MVN	55	38 x 3	10	24	
108MVG	55	38 x 3	10	24	
108MZB	55	38 x 3	10	24	

ABBINATA ART. 96GR ◆ COMBINED ART. 96GR

ART. 108MSV |

BANDELLA DIRITTA MURO SVASATA
STRAIGHT HINGE , COUNTERSUNK HOLES (WALL)

CODICE Code	LUNGHEZZA Length	SPESSORE Thickness	Ø	Pcs	€
108MSV VN	55	38 x 3	10	24	
108MSV VG	55	38 x 3	10	24	
108MSVZB	55	38 x 3	10	24	

ABBINATA ART. 96GR ◆ COMBINED ART. 96GR

ART. 110 |

CERNIERA 5x5
DOUBLE HINGE 5 X 5

CODICE Code	LUNGHEZZA Length	SPESSORE Thickness	Ø	Pcs	€
110VN	50x50	38 x 3	8	24	
110VG	50x50	38 x 3	8	24	
110ZB	50x50	38 x 3	8	24	

ART. 110 SV |

CERNIERA 5x5 FORI SVASATI
DOUBLE HINGE 5 X 5 COUNTERSUNK HOLES

CODICE Code	LUNGHEZZA Length	SPESSORE Thickness	Ø	Pcs	€
110SVVN	50x50	38 x 3	8	24	
110SVVG	50x50	38 x 3	8	24	
110SVZB	50x50	38 x 3	8	24	

ART. 112 |

CERNIERA 5x5 ZANCATA
DOUBLE HINGE 5 X 5

CODICE Code	LUNGHEZZA Length	SPESSORE Thickness	ZANCA Fold	Ø	Pcs	€
112VN	50x50	38 x 3	ZA=12	8	24	
112VG	50x50	38 x 3	ZA=12	8	24	
112ZB	50x50	38 x 3	ZA=12	8	24	

ART. 112SV |

CERNIERA 5x5 ZANCATA FORI SVASATI
DOUBLE HINGE 5 X 5 45° BENT, COUNTERSUNK HOLES

CODICE Code	LUNGHEZZA Length	SPESSORE Thickness	ZANCA Fold	Ø	Pcs	€
112SVVN	50x50	38 x 3	ZA=12	8	24	
112SVVG	50x50	38 x 3	ZA=12	8	24	
112SVZB	50x50	38 x 3	ZA=12	8	24	

ART. 115 |

CERNIERA 5x5 CON FERMO
DOUBLE HINGE 5 X 5 WITH LOCK

CODICE Code	LUNGHEZZA Length	SPESSORE Thickness	Ø	Pcs	€
115VN	50x50	38 x 3	8	24	
115VG	50x50	38 x 3	8	24	
115ZB	50x50	38 x 3	8	24	

ART. 115 SV |

CERNIERA 5x5 CON FERMO SVASATA
DOUBLE HINGE 5 X 5 WITH LOCK , COUNTERSUNK HOLES

CODICE Code	LUNGHEZZA Length	SPESSORE Thickness	Ø	Pcs	€
115SV VN	50x50	38 x 3	8	24	
115SV VG	50x50	38 x 3	8	24	
115SVZB	50x50	38 x 3	8	24	

ART. 116 |

CERNIERA 6,5x6,5
DOUBLE HINGE 6,5 X 6,5

CODICE Code	LUNGHEZZA Length	SPESSORE Thickness	Ø	Pcs	€
116VN	65x65	38 x 3	8	24	
116VG	65x65	38 x 3	8	24	
116ZB	65x65	38 x 3	8	24	

ART. 116SV |

CERNIERA 6,5x6,5 FORI SVASATI
DOUBLE HINGE 6,5 X 6,5 , COUNTERSUNK HOLES

CODICE Code	LUNGHEZZA Length	SPESSORE Thickness	Ø	Pcs	€
116SV VN	65x65	38 x 3	8	24	
116SV VG	65x65	38 x 3	8	24	
116SVZB	65x65	38 x 3	8	24	

ART. 300

BANDELLA SNODO Ø 10 OCCHIO CENTRALE «serie Tonda»
DOUBLE HINGE Ø 10 WITH CENTRAL EYE «series Tonda»



ART. 300LA

BANDELLA SNODO Ø 10 OCCHIO LATERALE «serie Tonda»
DOUBLE HINGE Ø 10 WITH OFF-CENTRE EYE «series Tonda»



VERNICIATO NERO PAINTED BLACK

Come ordinare - How to order: es - ex 3001620VN

Codice - Code = 300 (bandelle snodo ø 10 occhio centrale - double hinge ø 10 with central eye)

Misure - Size A → = 16 cm

Misure - Size B ↓ = 20 cm

Finitura - Finishing = VN (verniciato nero - painted black)

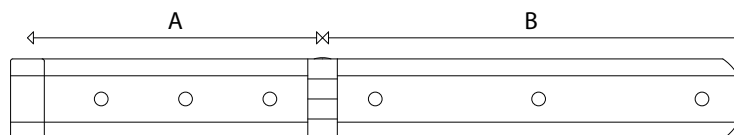

Misure in cm — Sizes in cm

B ↓ A →	DA 8 A 14	15 - 16	DA 17 A 20	21 - 22	23 - 24	25 - 26	27 - 28	29 - 30	31 - 32
X 8									
X 10									
X 12									
X 14									
X 16									
X 18									
X 20									
X 22									
X 25									
X 30									
X 35									
X 40									
X 45									
X 50									

ART. 300

BANDELLA SNODO Ø 10 OCCHIO CENTRALE «serie Tonda»
DOUBLE HINGE Ø 10 WITH CENTRAL EYE «series Tonda»

ART. 300LA

BANDELLA SNODO Ø 10 OCCHIO LATERALE «serie Tonda»
DOUBLE HINGE Ø 10 WITH OFF-CENTRE EYE «series Tonda»

VERNICIATO GRIGIO PAINTED GREY

Come ordinare - How to order: es - ex 3001620VG

Codice - Code = 300 (bandelle snodo ø 10 occhio centrale - double hinge ø 10 with central eye)

Misure - Size A → = 16 cm

Misure - Size B ↓ = 20 cm

Finitura - Finishing = VG (verniciato grigio - painted grey)

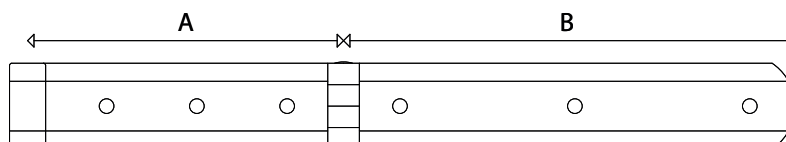

Misure in cm — Sizes in cm

B ↓ A →	DA 8 A 14	15 - 16	DA 17 A 20	21 - 22	23 - 24	25 - 26	27 - 28	29 - 30	31 - 32
X 8									
X 10									
X12									
X14									
X16									
X18									
X20									
X22									
X25									
X30									
X35									
X40									
X45									
X50									

ART. 300 |

BANDELLA SNODO Ø 10 OCCHIO CENTRALE «serie Tonda»
DOUBLE HINGE Ø 10 WITH CENTRAL EYE «series Tonda»



ART. 300LA |

BANDELLA SNODO Ø 10 OCCHIO LATERALE «serie Tonda»
DOUBLE HINGE Ø 10 WITH OFF-CENTRE EYE «series Tonda»



ZINCATO BIANCO WHITE GALVANIZED

Come ordinare - How to order: es - ex 3001620ZB

Codice - Code = 300 (bandelle snodo ø 10 occhio centrale - double hinge ø 10 with central eye)
Misure - Size A → = 16 cm
Misure - Size B ↓ = 20 cm
Finitura - Finishing = ZB (zincato bianco - white galvanized)

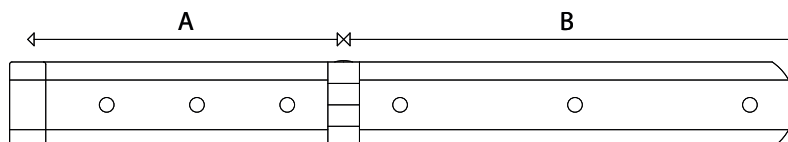

Misure in cm — Sizes in cm

B ↓ A →	DA 8 A 14	15 - 16	DA 17 A 20	21 - 22	23 - 24	25 - 26	27 - 28	29 - 30	31 - 32
X 8									
X 10									
X 12									
X 14									
X 16									
X 18									
X 20									
X 22									
X 25									
X 30									
X 35									
X 40									
X 45									
X 50									

ART. 305

ASENERE «serie Tonda»
TWIN HINGE "Series Tonda"

CODICE CODE	MISURE cm SIZE cm	Pcs	VN	VG	ZB
3058...	8 X 8	12			
30510...	10 X 10	12			
30512...	12 X 12	12			
30514...	14 X 14	12			
30516...	16 X 16	12			
30518...	18 X 18	12			
30520...	20 X 20	12			
30525...	25 X 25	12			
30530...	30 X 30	12			
30535...	35 X 35	12			
30540...	40 X 40	12			



ART. 305ZA

ASENERE ZANCATE «serie Tonda»
TWIN HINGE, 45° BENT "Series Tonda"

CODICE CODE	MISURE cm SIZE cm	ZANCA FOLD	Pcs	VN	VG	ZB
305ZA8...	8 X 8	12	12			
305ZA10...	10 X 10	12	12			
305ZA12...	12 X 12	12	12			
305ZA14...	14 X 14	12	12			
305ZA16...	16 X 16	12	12			
305ZA18...	18 X 18	12	12			
305ZA20...	20 X 20	12	12			
305ZA25...	25 X 25	12	12			
305ZA30...	30 X 30	12	12			

ART. 310 |

BANDELLA A SNODO FINALE A "T" Serie TONDA
 DOUBLE HINGE WITH "T" SHAPED OUTER ELEMENT
 CENTRAL EYE "Series TONDA"



CODICE CODE	MISURE cm SIZE cm	Ø	Pcs	VN	VG	ZB
31012...	12 X 16	10	12			
31014...	14 X 16	10	12			
31016...	16 X 16	10	12			
31018...	18 X 16	10	12			
31020...	20 X 16	10	12			

ART. 310LA |

BANDELLA A SNODO FINALE A "T" OCCHIO LATERALE
 Serie TONDA
 DOUBLE HINGE WITH "T" SHAPED OUTER ELEMENT
 OFF-CENTRE EYE "Series TONDA"



CODICE CODE	MISURE cm SIZE cm	Ø	Pcs	VN	VG	ZB
310LA12...	12 X 16	10	12			
310LA14...	14 X 16	10	12			
310LA16...	16 X 16	10	12			
310LA18...	18 X 16	10	12			
310LA20...	20 X 16	10	12			

ART. 315

BANDELLA SNODO Ø 8 ALLA PADOVANA «serie Tonda»
 DOUBLE HINGE Ø 8 TYPE PADUA WITH OFF-CENTRE EYE «series Tonda»



ABBINATA ART. 95GR / 97GR ◆ COMBINED ART. 95GR / 97 GR

● VERNICIATO NERO PAINTED BLACK

Come ordinare - How to order: es - ex 3151530VN

Codice - Code = 315 (bandelle snodo ø 8 occhio centrale - double hinge ø 8 with central eye)

Misure - Size A → = 15 cm

Misure - Size B ↓ = 30 cm

Finitura - Finishing = VN (verniciato nero - painted black)

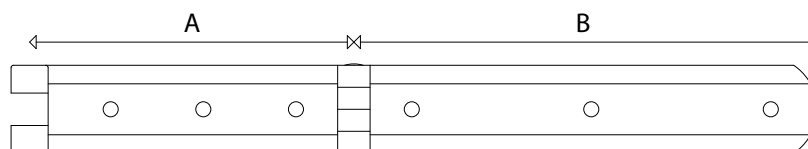

Misure in cm — Sizes in cm

B ↓ A →	DA 8 A 14	15 -16	DA 17 A 20	21 -22	23 -24	25 - 26	27 - 28	29 - 30	31 - 32
X 8									
X 10									
X12									
X14									
X16									
X18									
X20									
X22									
X25									
X30									
X35									
X40									
X45									
X50									

ART. 315

BANDELLA SNODO Ø 8 ALLA PADOVANA «serie Tonda»
DOUBLE HINGE Ø 8 TYPE PADUA WITH OFF-CENTRE EYE «series Tonda»

ABBINATA ART. 95GR / 97GR ◆ COMBINED ART. 95GR / 97 GR

VERNICIATO GRIGIO PAINTED GREY

Misure in cm – Sizes in cm

B ↓ A →	DA 8 A 14	15 - 16	DA 17 A 20	21 - 22	23 - 24	25 - 26	27 - 28	29 - 30	31 - 32
X 8									
X 10									
X 12									
X 14									
X 16									
X 18									
X 20									
X 22									
X 25									
X 30									
X 35									
X 40									
X 45									
X 50									

ZINCATO BIANCO WHITE GALVANIZED

Misure in cm – Sizes in cm

B ↓ A →	DA 8 A 14	15 - 16	DA 17 A 20	21 - 22	23 - 24	25 - 26	27 - 28	29 - 30	31 - 32
X 8									
X 10									
X 12									
X 14									
X 16									
X 18									
X 20									
X 22									
X 25									
X 30									
X 35									
X 40									
X 45									
X 50									

ART. 500

BANDELLA SNODO Ø 10 OCCHIO LATERALE «serie Jolly»
DOUBLE HINGE Ø 10 WITH OFF-CENTRE EYE «series Jolly»



ART. 500LA

BANDELLA SNODO Ø 10 OCCHIO LATERALE «serie Jolly»
DOUBLE HINGE Ø 10 WITH OFF-CENTRE EYE «series Jolly»



● VERNICIATO NERO PAINTED BLACK

Come ordinare - How to order: es - ex 5001425VN

Codice - Code = 500 (bandelle snodo ø 10 occhio centrale - double hinge ø 10 with central eye)

Misure - Size A → = 14 cm

Misure - Size B ↓ = 25 cm

Finitura - Finishing = VN (verniciato nero - painted black)

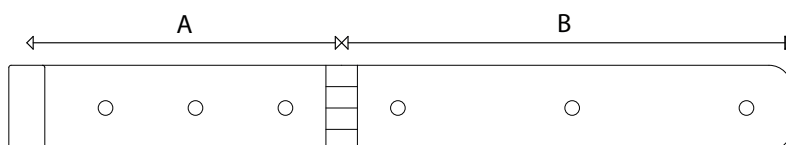

Misure in cm — Sizes in cm

B ↓ A →	DA 8 A 14	15 -16	DA 17 A 20	21 -22	23 -24	25 - 26	27 - 28	29 - 30	31 - 32
X 8									
X 10									
X12									
X14									
X16									
X18									
X20									
X22									
X25									
X30									
X35									
X40									
X45									
X50									

ART. 500

BANDELLA SNODO Ø 10 OCCHIO LATERALE «serie Jolly»
DOUBLE HINGE Ø 10 WITH CENTRE EYE «series Jolly»



ART. 500LA

BANDELLA SNODO Ø 10 OCCHIO LATERALE «serie Jolly»
DOUBLE HINGE Ø 10 WITH OFF-CENTRE EYE «series Jolly»



VERNICIATO GRIGIO PAINTED GREY

Come ordinare - How to order: es - ex 5001425VG

Codice - Code = 500 (bandelle snodo ø 10 occhio centrale - double hinge ø 10 with central eye)
Misure - Size A → = 14 cm
Misure - Size B ↓ = 25 cm
Finitura - Finishing = VG (verniciato grigio - painted grey)

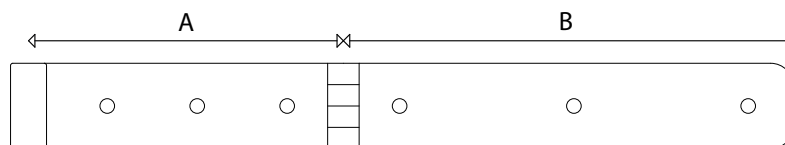

Misure in cm — Sizes in cm

B ↓ A →	DA 8 A 14	15 -16	DA 17 A 20	21 -22	23 -24	25 - 26	27 - 28	29 - 30	31 - 32
X 8									
X 10									
X12									
X14									
X16									
X18									
X20									
X22									
X25									
X30									
X35									
X40									
X45									
X50									

ART. 500

BANDELLA SNODO Ø 10 OCCHIO CENTRALE «serie Jolly»
DOUBLE HINGE Ø 10 WITH CENTRAL EYE «series Jolly»



ART. 500LA

BANDELLA SNODO Ø 10 OCCHIO LATERALE «serie Jolly»
DOUBLE HINGE Ø 10 WITH OFF-CENTRAL EYE «series Jolly»



ZINCATO BIANCO WHITE GALVANIZED

Come ordinare - How to order: es - ex 5001425ZB

Codice - Code = 500 (bandelle snodo ø 10 occhio centrale - double hinge ø 10 with central eye)

Misure - Size A → = 14 cm

Misure - Size B ↓ = 25 cm

Finitura - Finishing = ZB (zincato bianco - white galvanized)

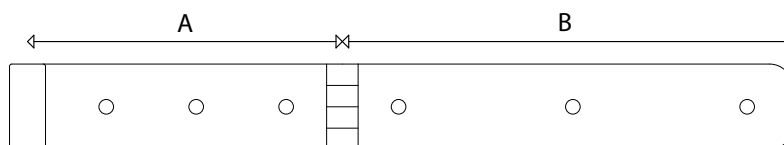

Misure in cm — Sizes in cm

B ↓ A →	DA 8 A 14	15 -16	DA 17 A 20	21 -22	23 -24	25 - 26	27 - 28	29 - 30	31 - 32
X 8									
X 10									
X12									
X14									
X16									
X18									
X20									
X22									
X25									
X30									
X35									
X40									
X45									
X50									

ART. 505

ASENERE «serie Jolly»
TWIN HINGE «series Jolly»

CODICE CODE	MISURE cm SIZE cm	PCS	VN	VG	ZB
5058...	8 X 8	12			
50510...	10 X 10	12			
50512...	12 X 12	12			
50514...	14 X 14	12			
50516...	16 X 16	12			
50518...	18 X 18	12			
50520...	20 X 20	12			
50525...	25 X 25	12			
50530...	30 X 30	12			
50535...	35 X 35	12			
50540...	40 X 40	12			

ART. 505ZA

ASENERE ZANCATE «serie Jolly»
TWIN HINGE 45° BENT «series Jolly»

CODICE CODE	MISURE cm SIZE cm	ZANCA FOLD	PCS	VN	VG	ZB
505ZA8...	8 X 8	12	12			
505ZA10...	10 X 10	12	12			
505ZA12...	12 X 12	12	12			
505ZA14...	14 X 14	12	12			
505ZA16...	16 X 16	12	12			
505ZA18...	18 X 18	12	12			
505ZA20...	20 X 20	12	12			
505ZA25...	25 X 25	12	12			
505ZA30...	30 X 30	12	12			

21

BANDELLE A SNODO • DOUBLE HINGES

ART. 515 |

BANDELLA SNODO Ø 8 ALLA PADOVANA «serie Jolly»
 DOUBLE HINGE Ø 8 TYPE PADUA WITH OFF-CENTRE EYE «series Jolly»



ABBINATA ART. 95GR / 97GR ◆ COMBINED ART. 95GR / 97 GR

● VERNICIATO NERO PAINTED BLACK

Come ordinare - How to order: es - ex 5151530VN

Codice - Code = 515 (bandelle snodo ø 8 alla padovana - double hinge ø 8 with type padua with off-centre eye)

Misure - Size A → = 15 cm

Misure - Size B ↓ = 30 cm

Finitura - Finishing = VN (verniciato nero - painted black)

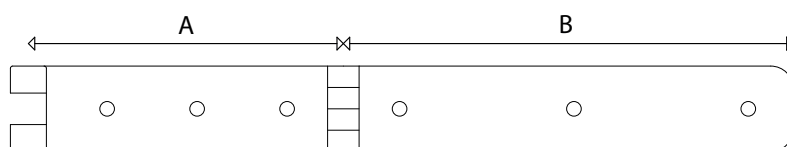

Misure in cm — Sizes in cm

B ↓ A →	DA 8 A 14	15 -16	DA 17 A 20	21 -22	23 -24	25 - 26	27 - 28	29 - 30	31 - 32
X 8									
X 10									
X12									
X14									
X16									
X18									
X20									€ 4,54
X22									
X25									
X30									
X35									
X40									
X45									
X50									

ART. 515 |

BANDELLA SNODO Ø 8 ALLA PADOVANA «serie Jolly»
DOUBLE HINGE Ø 8 TYPE PADUA WITH OFF-CENTRE EYE «series Jolly»

ABBINATA ART. 95GR / 97GR ◆ COMBINED ART. 95GR / 97 GR

VERNICIATO GRIGIO PAINTED GREY

Misure in cm — Sizes in cm

B ↓ A →	DA 8 A 14	15 -16	DA 17 A 20	21 -22	23 -24	25 - 26	27 - 28	29 - 30	31 - 32
X 8									
X 10									
X12									
X14									
X16									
X18									
X20									
X22									
X25									
X30									
X35									
X40									
X45									
X50									

ZINCATO BIANCO WHITE GALVANIZED

Misure in cm — Sizes in cm

B ↓ A →	DA 8 A 14	15 -16	DA 17 A 20	21 -22	23 -24	25 - 26	27 - 28	29 - 30	31 - 32
X 8									
X 10									
X12									
X14									
X16									
X18									
X20									
X22									
X25									
X30									
X35									
X40									
X45									
X50									

ART. 600 |

BANDELLA A SNODO Ø 10 «serie Venezia»
DOUBLE HINGE Ø 10 WITH CENTRAL EYE «series Venezia»

ART. 600LA |

BANDELLA A SNODO Ø 10 OCCHIO LATERALE «serie Venezia»
DOUBLE HINGE Ø 10 WITH OFF-CENTRE EYE «series Venezia»

CODICE Code	MISURE -A- cm SIZES -A- cm	SPESSORE Thickness	Ø	Pcs	€
600(LA)VN	DA 8 A 20 X 10	3	10	12	
600(LA)VG	DA 8 A 20 X 10	3	10	12	
600(LA)ZB	DA 8 A 20 X 10	3	10	12	

SPECIFICARE PRIMA PARTE (A) NELL' ORDINE ◆ SPECIFY THE FIRST PART (A) IN ORDER

ART. 602 |

BANDELLA A SNODO Ø 10 ALLA PADOVANA «serie Venezia»
DOUBLE HINGE Ø 10 TYPE PADUA WITH OFF-CENTRAL EYE «series Venezia»

ART. 602LA |

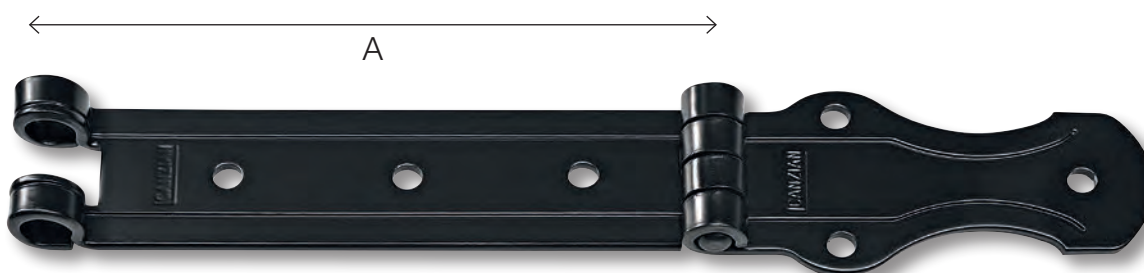
BANDELLA A SNODO Ø 10 ALLA PADOVANA «serie Venezia»
DOUBLE HINGE Ø 10 TYPE PADUA WITH OFF-CENTRAL EYE «series Venezia»

CODICE Code	MISURE -A- cm SIZES -A- cm	SPESSORE Thickness	Ø	Pcs	€
602VN	DA 8 A 20 X 10	3	8	12	
602VG	DA 8 A 20 X 10	3	8	12	
602ZB	DA 8 A 20 X 10	3	8	12	

SPECIFICARE PRIMA PARTE (A) NELL' ORDINE ◆ SPECIFY THE FIRST PART (A) IN ORDER

ABBINATA ART. 95GR / 97GR ◆ COMBINED ART. 95GR / 97 GR

ART. 605

ASENERE «serie Venezia»
TWIN HINGE «series Venezia»

CODICE Code	MISURE cm Size cm	SPESSORE Thickness	Ø	Pcs	€
605VN	10X10	3	8	12	
605VG	10X10	3	8	12	
605ZB	10X10	3	8	12	

ART. 605ZA

ASENERE ZANCATA «serie Venezia»
TWIN HINGE 45° BENT «series Venezia»

CODICE Code	MISURE cm Size cm	SPESSORE Thickness	ZANCA Fold	Ø	Pcs	€
605ZAVN	10X10	3	ZA=15	8	12	
605ZAVG	10X10	3	ZA=15	8	12	
605ZAZB	10X10	3	ZA=15	8	12	

ART. 318 |

BANDELLA DIRITTA Ø 10 «serie Tonda»
STRAIGHT HINGE Ø 10 «series Tonda»

CODICE Code	LUNGHEZZA Length	SPESSORE Thickness	Ø	Pcs	VN	VG	ZB
3188...	80	38 X 3	10	12			
31810...	100	38 X 3	10	12			
31812...	120	38 X 3	10	12			
31814...	140	38 X 3	10	12			
31816...	160	38 X 3	10	12			
31820...	200	38 X 3	10	12			
31825...	250	38 X 3	10	12			
31830...	300	38 X 3	10	12			
31835...	350	38 X 3	10	12			
31840...	400	38 X 3	10	12			

ART. 318LA |

BANDELLA DIRITTA Ø 10 OCCHIO LATERALE «serie Tonda»
STRAIGHT HINGE Ø 10 WITH OFF-CENTRE EYE «series Tonda»

CODICE Code	LUNGHEZZA Length	SPESSORE Thickness	Ø	Pcs	VN	VG	ZB
318LA8...	80	38 X 3	10	12			
318LA10...	100	38 X 3	10	12			
318LA12...	120	38 X 3	10	12			
318LA14...	140	38 X 3	10	12			
318LA16...	160	38 X 3	10	12			
318LA20...	200	38 X 3	10	12			
318LA25...	250	38 X 3	10	12			
318LA30...	300	38 X 3	10	12			
318LA35...	350	38 X 3	10	12			
318LA40...	400	38 X 3	10	12			

ART. 318SB

BANDELLA DRITTA Ø 10 A SBALZO «serie Tonda»
STRAIGHT HINGE Ø 10 WITH EMBOSSMENT «series Tonda»

CODICE Code	LUNGHEZZA Length	SPESSORE Thickness	Ø	SBALZO Fold	Pcs	VN	VG	ZB
318SB20...	200	38 X 3	10	3	12			
318SB25...	250	38 X 3	10	3	12			
318SB30...	300	38 X 3	10	3	12			
318SB35...	350	38 X 3	10	3	12			

ART. 320D

BANDELLA DRITTA Ø 12 «serie Tonda»
STRAIGHT HINGE Ø 12 «series Tonda»

CODICE Code	LUNGHEZZA Length	SPESSORE Thickness	Ø	Pcs	VN	VG	ZB
320D20...	200	38 X 3,5	12	12			
320D25...	250	38 X 3,5	12	12			
320D30...	300	38 X 3,5	12	12			
320D35...	350	38 X 3,5	12	12			
320D40...	400	38 X 4	12	12			
320D45...	450	38 X 4	12	12			
320D50...	500	38 X 4	12	12			
320D60...	600	38 X 4	12	12			

ART. 320LA

BANDELLA DIRITTA Ø 12 OCCHIO LATERALE «serie Tonda»
 STRAIGHT HINGE Ø 12 WITH OFF-CENTRE EYE «series Tonda»



CODICE Code	LUNGHEZZA Length	SPESSORE Thickness	Ø	Pcs	VN	VG	ZB
320LA20...	200	38 X 3,5	12	12			
320LA25...	250	38 X 3,5	12	12			
320LA30...	300	38 X 3,5	12	12			
320LA35...	350	38 X 3,5	12	12			
320LA40...	400	38 X 4	12	12			
320LA45...	450	38 X 4	12	12			
320LA50...	500	38 X 4	12	12			
320LA60...	600	38 X 4	12	12			

ART. 320SB

BANDELLA DIRITTA Ø 12 A SBALZO «serie Tonda»
 STRAIGHT HINGE Ø 12 WITH EMBOSSEMENT «series Tonda»



CODICE Code	LUNGHEZZA Length	SPESSORE Thickness	Ø	SBALZO Fopld	Pcs	VN	VG	ZB
320SB20...	200	38 X 3,5	12	3	12			
320SB25...	250	38 X 3,5	12	3	12			
320SB30...	300	38 X 3,5	12	3	12			
320SB35...	350	38 X 3,5	12	3	12			

ART. 320Z

BANDELLA ZANCATA Ø 12 «serie Tonda»
STRAIGHT HINGE Ø 12 90° BENT «series Tonda»

CODICE Code	LUNGHEZZA Length	SPESSORE Thickness	ZANCA Fold	Ø	Pcs	VN	VG	ZB
320Z20...	200	38 X 3,5	ZA=45	12	12			
320Z25...	250	38 X 3,5	ZA=45	12	12			
320Z30...	300	38 X 3,5	ZA=45	12	12			
320Z35...	350	38 X 3,5	ZA=45	12	12			
320Z40...	400	38 X 4	ZA=45	12	12			
320Z45...	450	38 X 4	ZA=45	12	12			
320Z50...	500	38 X 4	ZA=45	12	12			
320Z60...	600	38 X 4	ZA=45	12	12			

ART. 320Z6

BANDELLA ZANCATA h 60 Ø 12 «serie Tonda»
STRAIGHT HINGE Ø 12 90° BENT h 60 «series Tonda»

CODICE Code	LUNGHEZZA Length	SPESSORE Thickness	ZANCA Fold	Ø	Pcs	VN	VG	ZB
320Z620...	200	38 X 4	ZA=60	12	12			
320Z625...	250	38 X 4	ZA=60	12	12			
320Z630...	300	38 X 4	ZA=60	12	12			
320Z635...	350	38 X 4	ZA=60	12	12			
320Z640...	400	38 X 4	ZA=60	12	12			
320Z645...	450	38 X 4	ZA=60	12	12			
320Z650...	500	38 X 4	ZA=60	12	12			
320Z660...	600	38 X 4	ZA=60	12	12			

ART. 320ZF

BANDELLA ZANCA A FILO Ø 12 «serie Tonda»
STRAIGHT HINGE Ø 12 45° BENT «series Tonda»

CODICE Code	LUNGHEZZA Length	SPESSORE Thickness	ZANCA Fold	Ø	Pcs	VN	VG	ZB
320ZF20...	200	38 X 3,5	ZA=24	12	12			
320ZF25...	250	38 X 3,5	ZA=24	12	12			
320ZF30...	300	38 X 3,5	ZA=24	12	12			
320ZF35...	350	38 X 3,5	ZA=24	12	12			
320ZF40...	400	38 X 4	ZA=24	12	12			



ART. 325

BANDELLA DIRITTA ALLA VICENTINA «serie Tonda»
VICENZA TYPE HINGE «series Tonda»

CODICE Code	LUNGHEZZA Length	SPESSORE Thickness	Ø	Pcs	VN	VG	ZB
32510...	100	3	8	12			
32512...	120	3	8	12			
32516...	160	3	8	12			
32518...	180	3	8	12			
32520...	200	3	8	12			
32525...	250	3	8	12			

ART. 518

BANDELLA DIRITTA Ø 10 «serie Jolly»
STRAIGHT HINGE Ø 10 «series Jolly»

CODICE Code	LUNGHEZZA Length	SPESSORE Thickness	Ø	Pcs	VN	VG	ZB
5188...	80	38 X 3	10	12			
51810...	100	38 X 3	10	12			
51812...	120	38 X 3	10	12			
51814...	140	38 X 3	10	12			
51816...	160	38 X 3	10	12			
51820...	200	38 X 3	10	12			
51825...	250	38 X 3	10	12			
51830...	300	38 X 3	10	12			
51835...	350	38 X 3	10	12			
51840...	400	38 X 3	10	12			

ART. 518LA

BANDELLA DIRITTA Ø 10 OCCHIO LATERALE «serie Jolly»
STRAIGHT HINGE Ø 10 WITH OFF-CENTRE EYE «series Jolly»

CODICE Code	LUNGHEZZA Length	SPESSORE Thickness	Ø	Pcs	VN	VG	ZB
518LA8...	80	38 X 3	10	12			
518LA10...	100	38 X 3	10	12			
518LA12...	120	38 X 3	10	12			
518LA14...	140	38 X 3	10	12			
518LA16...	160	38 X 3	10	12			
518LA20...	200	38 X 3	10	12			
518LA25...	250	38 X 3	10	12			
518LA30...	300	38 X 3	10	12			
518LA35...	350	38 X 3	10	12			
518LA40...	400	38 X 3	10	12			

31

BANDELLE • STRAIGHT HINGES

ART. 518SB

BANDELLA DIRITTA Ø 10 A SBALZO «serie Jolly»
STRAIGHT HINGE Ø 10 WITH OFF-CENTRE EYE «series Jolly»



CODICE Code	LUNGHEZZA Length	SPESSORE Thickness	Ø	SBALZO Fold	Pcs	VN	VG	ZB
518SB20...	200	38 X 3	10	3	12			
518SB25...	250	38 X 3	10	3	12			
518SB30...	300	38 X 3	10	3	12			
518SB35...	350	38 X 3	10	3	12			



ART. 520D

BANDELLA DIRITTA Ø 12 «serie Jolly»
STRAIGHT HINGE Ø 12 «series Jolly»

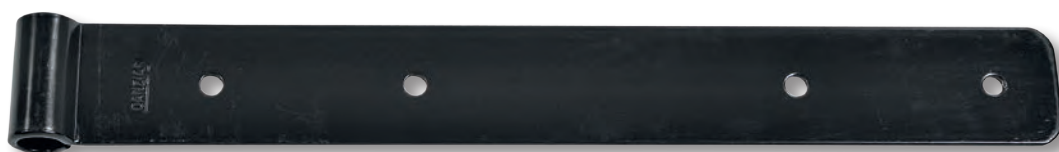

CODICE Code	LUNGHEZZA Length	SPESSORE Thickness	Ø	Pcs	VN	VG	ZB
520D20...	200	38 X 3,5	12	12			
520D25...	250	38 X 3,5	12	12			
520D30...	300	38 X 3,5	12	12			
520D35...	350	38 X 3,5	12	12			
520D40...	400	38 X 4	12	12			
520D45...	450	38 X 4	12	12			
520D50...	500	38 X 4	12	12			
520D60...	600	38 X 4	12	12			

ART. 520LA |

BANDELLA DIRITTA Ø 12 OCCHIO LATERALE «serie Jolly»
 STRAIGHT HINGE Ø 12 WITH OFF-CENTRE EYE «series Jolly»



CODICE Code	LUNGHEZZA Length	SPESSORE Thickness	Ø	Pcs	VN	VG	ZB
520LA20...	200	38 X 3,5	12	12			
520LA25...	250	38 X 3,5	12	12			
520LA30...	300	38 X 3,5	12	12			
520LA35...	350	38 X 3,5	12	12			
520LA40...	400	38 X 4	12	12			
520LA45...	450	38 X 4	12	12			
520LA50...	500	38 X 4	12	12			
520LA60...	600	38 X 4	12	12			

ART. 520SB |

BANDELLA DIRITTA Ø 12 A SBALZO «serie Jolly»
 STRAIGHT HINGE Ø 12 WITH EMBOSSEMENT «series Jolly»



CODICE Code	LUNGHEZZA Length	SPESSORE Thickness	Ø	SBALZO Fold	Pcs	VN	VG	ZB
520SB20...	200	38 X 3,5	12	3	12			
520SB25...	250	38 X 3,5	12	3	12			
520SB30...	300	38 X 3,5	12	3	12			
520SB35...	350	38 X 3,5	12	3	12			

ART. 520Z

BANDELLA ZANCATA Ø 12 «serie Jolly»
STRAIGHT HINGE Ø 12 90° BENT «series Jolly»

CODICE Code	LUNGHEZZA Length	SPESSORE Thickness	ZANCA Fold	Ø	Pcs	VN	VG	ZB
520Z20...	200	38 X 3,5	ZA=45	12	12			
520Z25...	250	38 X 3,5	ZA=45	12	12			
520Z30...	300	38 X 3,5	ZA=45	12	12			
520Z35...	350	38 X 3,5	ZA=45	12	12			
520Z40...	400	38 X 4	ZA=45	12	12			
520Z45...	450	38 X 4	ZA=45	12	12			
520Z50...	500	38 X 4	ZA=45	12	12			
520Z60...	600	38 X 4	ZA=45	12	12			



ART. 520Z6

BANDELLA ZANCATA h 60 Ø 12 «serie Jolly»
STRAIGHT HINGE Ø 12 90° BENT h 60 «series Jolly»

CODICE Code	LUNGHEZZA Length	SPESSORE Thickness	ZANCA Fold	Ø	Pcs	VN	VG	ZB
520Z620...	200	38 X 4	ZA=60	12	12			
520Z625...	250	38 X 4	ZA=60	12	12			
520Z630...	300	38 X 4	ZA=60	12	12			
520Z635...	350	38 X 4	ZA=60	12	12			
520Z640...	400	38 X 4	ZA=60	12	12			
520Z645...	450	38 X 4	ZA=60	12	12			
520Z650...	500	38 X 4	ZA=60	12	12			
520Z660...	600	38 X 4	ZA=60	12	12			

ART. 520ZF |

BANDELLA ZANCA A FILO Ø 12 «serie Jolly»
STRAIGHT HINGE Ø 12 45° BENT «series Jolly»



CODICE Code	LUNGHEZZA Length	SPESSORE Thickness	ZANCA Fold	Ø	Pcs	VN	VG	ZB
520ZF20...	200	38 X 3,5	ZA=24	12	12			
520ZF25...	250	38 X 3,5	ZA=24	12	12			
520ZF30...	300	38 X 3,5	ZA=24	12	12			
520ZF35...	350	38 X 3,5	ZA=24	12	12			
520ZF40...	400	38 X 4	ZA=24	12	12			

ART. 525 |

BANDELLA DIRITTA ALLA VICENTINA «serie Jolly»
VICENZA TYPE HINGE «series Jolly»



ABBINATA ART. 95GR / 97GR ◆ COMBINED ART. 95GR / 97 GR

CODICE Code	LUNGHEZZA Length	SPESSORE Thickness	Ø	Pcs	VN	VG	ZB
52510	100	3	8	12			
52512	120	3	8	12			
52516	160	3	8	12			
52518	180	3	8	12			
52520	200	3	8	12			
52525	250	3	8	12			

ART. 220D

BANDELLA DIRITTA «serie UNI»
STRAIGHT HINGE «series UNI»



CODICE Code	MISURE Size	Ø	Pcs	€
220DVN	180x3,5	12	12	
220DVG	180x3,5	12	12	
220DZB	180x3,5	12	12	

ART. 220Z

BANDELLA ZANCATA «serie UNI»
STRAIGHT HINGE UNI 90° BENT «series UNI»



CODICE Code	MISURE Size	ZANCA Fold	Ø	Pcs	€
220ZVN	180x3,5	ZA=40	12	12	
220ZVG	180x3,5	ZA=40	12	12	
220ZZB	180x3,5	ZA=40	12	12	

ART. 330

BANDELLA A "T" Ø 10 DIRITTA «serie Tonda»
T-SHAPED HINGE Ø 10 WITH CENTRAL EYE «series Tonda»



CODICE Code	MISURE Size	INTERASSE Distance	Ø	Pcs	€
330VN	160 X 28	I =44	10	12	
330VG	160 X 28	I =44	10	12	
330ZB	160 X 28	I =44	10	12	

ART. 330LA

BANDELLA A "T" Ø 10 OCCHIO LATERALE «serie Tonda»
T-SHAPED HINGE Ø 10 WITH OFF-CENTRE EYE «series Tonda»



CODICE Code	MISURE Size	INTERASSE Distance	Ø	Pcs	€
330LAVN	160 X 28	I =41	10	12	
330LAVG	160 X 28	I =41	10	12	
330LAZB	160 X 28	I =41	10	12	

37

BANDELLE A "T" • "T" SHAPED HINGES

ART. 330LG

BANDELLA A "T" LUNGA Ø 10 DIRITTA «serie Tonda»
T-SHAPED LONG HINGE Ø 10 WITH CENTRAL EYE «series Tonda»



CODICE Code	MISURE Size	INTERASSE Distance	Ø	Pcs	€
330LGVN	160 X 28	I =62	10	12	
330LGVG	160 X 28	I =62	10	12	
330LGZB	160 X 28	I =62	10	12	

ART. 330GLA

BANDELLA A "T" LUNGA Ø 10 OCCHIO LATERALE «serie Tonda»
T-SHAPED LONG HINGE Ø 10 WITH OFF-CENTRE EYE «series Tonda»



CODICE Code	MISURE Size	INTERASSE Distance	Ø	Pcs	€
330LGLAVN	160 X 28	I =59	10	12	
330LGLAVG	160 X 28	I =59	10	12	
330LGLAZB	160 X 28	I =59	10	12	

ART. 330SB

BANDELLA A "T" Ø 10 A SBALZO «serie Tonda»
T-SHAPED HINGE Ø 10 WITH EMBOSSEMENT «series Tonda»



CODICE Code	MISURE Size	INTERASSE Distance	SBALZO Fold	Ø	Pcs	€
330SBVN	160 X 28	I =59	3	10	12	
330SBVG	160 X 28	I =59	3	10	12	
330SBZB	160 X 28	I =59	3	10	12	

ART. 330ST

BANDELLA A "T" STRETTA Ø 10 OCCHIO LATERALE «serie Tonda»
T-SHAPED HINGE Ø 10 WITH OFF-CENTRE EYE «series Tonda»



CODICE Code	MISURE Size	INTERASSE Distance	Ø	Pcs	€
330STVN	160 X 28	I =30	10	12	
330STVG	160 X 28	I =30	10	12	
330STZB	160 X 28	I =30	10	12	

ART. 330ZA

BANDELLA A "T" ZANCATE Ø 10 «serie Tonda»
T-SHAPED HINGE Ø 10 90° BENT «series Tonda»



CODICE Code	MISURE Size	INTERASSE Distance	ZANCA Fold	Ø	Pcs	€
330ZAVN	160 X 28	I =35	ZA=38	10	12	
330ZAVG	160 X 28	I =35	ZA=38	10	12	
330ZAZB	160 X 28	I =35	ZA=38	10	12	

ART. 330ZF

BANDELLA A "T" ZANCA A FILO Ø 10 «serie Tonda»
T-SHAPED HINGE Ø 10 45° BENT «series Tonda»



CODICE Code	MISURE Size	INTERASSE Distance	ZANCA Fold	Ø	Pcs	€
330ZFVN	160 X 28	I =55	ZA=21	10	12	
330ZFVG	160 X 28	I =55	ZA=21	10	12	
332ZFZB	160 X 28	I =55	ZA=21	10	12	

ART. 332

BANDELLA A "T" Ø 12 «serie Tonda»
T-SHAPED HINGE Ø 12 WITH CENTRAL EYE «series Tonda»



CODICE Code	MISURE Size	INTERASSE Distance	Ø	Pcs	€
332VN	160 X 28	I =58	12	12	
332VG	160 X 28	I =58	12	12	
332ZB	160 X 28	I =58	12	12	

ART. 332LA

BANDELLA A "T" Ø 12 OCCHIO LATERALE «serie Tonda»
T-SHAPED HINGE Ø 12 WITH OFF-CENTRE EYE «series Tonda»



CODICE Code	MISURE Size	INTERASSE Distance	Ø	Pcs	€
332LAVN	160 X 28	I =55	12	12	
332LAVG	160 X 28	I =55	12	12	
332LAZB	160 X 28	I =55	12	12	

ART. 340 |

BANDELLA A DOPPIO "T"
T-SHAPED DOUBLE HINGE



CODICE Code	MISURE Size	INTERASSE Distance	Ø	Pcs	€
340VN	160X28	I =62	8	12	
340VG	160X28	I =62	8	12	
340ZB	160X28	I =62	8	12	



ART. 340ZA |

BANDELLA A DOPPIO "T" ZANCATE «serie Tonda»
T-SHAPED DOUBLE HINGE 45° BENT «series Tonda»



CODICE Code	MISURE Size	ZANCA Fold	Ø	Pcs	€
340ZAVN	160X28	ZA=12	8	12	
340ZAVG	160X28	ZA=12	8	12	
340ZAZB	160X28	ZA=12	8	12	

ART. 90

CERNIERA «serie Vienna»
DOUBLE HINGE «series Vienna»

CODICE Code	MISURE Size	SPESSORE THICKNESS	Ø	Pcs	€
90VN	60X74	2,5	8	24	
90VG	60X74	2,5	8	24	
90ZB	60X74	2,5	8	24	

ART. 90ZA

CERNIERA ZANCATA «serie Vienna»
DOUBLE HINGE 45° BENT «series Vienna»

CODICE Code	MISURE Size	SPESSORE THICKNESS	Ø	ZANCA FOLD	Pcs	€
90ZAVN	60X74	2,5	8	12	24	
90ZAVG	60X74	2,5	8	12	24	
90ZAZB	60X74	2,5	8	12	24	

ART. 92L

BANDELLA LEGNO «serie Vienna»
STRAIGHT HINGE (WOOD) «series Vienna»

CODICE Code	MISURE Size	SPESSORE THICKNESS	Ø	Pcs	€
92LVN	50X60	3	10	24	
92LVG	50X60	3	10	24	
92LZB	50X60	3	10	24	

ABBINATA ART. 94GR ◆ COMBINED ART. 94GR

ART. 92M

BANDELLA MURO «serie Vienna»
STRAIGHT HINGE (WALL) «series Vienna»

CODICE Code	MISURE Size	SPESSORE THICKNESS	Ø	Pcs	€
92MVN	50X60	3	10	24	
92MVG	50X60	3	10	24	
92MZB	50X60	3	10	24	

ABBINATA ART. 96GR ◆ COMBINED ART. 96GR

ART. 100L |

BANDELLA LEGNO «serie Eva»
STRAIGHT HINGE (WOOD) «series Eva»

CODICE Code	MISURE Size	SPESSORE THICKNESS	Ø	Pcs	€
100LVN	75X50	3	10	24	
100LVG	75X50	3	10	24	
100LZB	75X50	3	10	24	

ABBINATA ART. 30GR ◆ COMBINED ART. 30GR

SU RICHIESTA ANCHE CON FORI SVASATI ◆ UPON REQUEST COUNTERSUNK HOLES

ART. 100M |

BANDELLA MURO «serie Eva»
STRAIGHT HINGE (WALL) «series Eva»

CODICE Code	MISURE Size	SPESSORE THICKNESS	Ø	PCS	€
100MVN	60X50	3	10	24	
100MVG	60X50	3	10	24	
100MZB	60X50	3	10	24	

ABBINATA ART. 31GR ◆ COMBINED ART. 31GR

SU RICHIESTA ANCHE CON FORI SVASATI ◆ UPON REQUEST COUNTERSUNK HOLES

ART. 105 |

CERNIERA «serie Eva»
DOUBLE HINGE «series Eva»

CODICE Code	MISURE Size	SPESSORE THICKNESS	Ø	PCS	€
105VN	70X70	50X3	8	24	
105VG	70X70	50X3	8	24	
105ZB	70X70	50X3	8	24	

SU RICHIESTA ANCHE CON FORI SVASATI ◆ UPON REQUEST COUNTERSUNK HOLES

ART. 105ZA |

CERNIERA ZANCATA «serie Eva»
DOUBLE HINGE 45° BENT «series Eva»

CODICE Code	MISURE Size	SPESSORE THICKNESS	ZANCA Fold	Ø	Pcs	€
105ZAVN	70X70	50X3	12	8	24	
105ZAVG	70X70	50X3	12	8	24	
105ZAZB	70X70	50X3	12	8	24	

SU RICHIESTA ANCHE CON FORI SVASATI ◆ UPON REQUEST COUNTERSUNK HOLES

ART. 800L

BANDELLA LEGNO «serie Dubai»
STRAIGHT HINGE (WOOD) «series Dubai»



CODICE Code	MISURE Size	SPESSORE THICKNESS	Ø	Pcs	€
800LVN	78 X 48	3	10	24	
800LVG	78 X 48	3	10	24	
800LZB	78 X 48	3	10	24	

ABBINATA ART. 30GR ◆ COMBINED ART. 30GR

ART. 800M

BANDELLA MURO «serie Dubai»
STRAIGHT HINGE (WALL) «series Dubai»



CODICE Code	MISURE Size	SPESSORE THICKNESS	Ø	Pcs	€
800MVN	78 X 56	3	10	24	
800MVG	78 X 56	3	10	24	
800MZB	78 X 56	3	10	24	

ABBINATA ART. 31GR ◆ COMBINED ART. 31GR

ART. 850

CERNIERA «serie Dubai»
TWIN HINGE «series Dubai»



CODICE Code	MISURE Size	SPESSORE THICKNESS	Ø	Pcs	€
850VN	78 X 90	2,5	8	24	
850VG	78 X 90	2,5	8	24	
850ZB	78 X 90	2,5	8	24	

ART. A900

BANDELLA SNODATA OCCHIO LATERALE «serie Alphacan»
DOUBLE HINGE Ø 10 WITH OFF-CENTRE EYE «series Alphacan»

CODICE Code	MISURE SIZE	Ø	FORI HOLES	Pcs	VN	VG	ZB
A9001...	139 + 39	10	3 + 1	12			
A9002...	139 + 110	10	3 + 2	12			
A9003...	139 + 185	10	3 + 3	12			
A9004...	139 + 256	10	3 + 4	12			
A9005...	139 + 331	10	3 + 5	12			
A9006...	139 + 402	10	3 + 6	12			
A9007...	139 + 477	10	3 + 7	12			
A9008...	139 + 548	10	3 + 8	12			
A9009...	139 + 623	10	3 + 9	12			

ART. A900ZF

BANDELLA SNODATA ZANCA A FILO «serie Alphacan»
DOUBLE HINGE Ø 10 45° BENT «series Alphacan»

CODICE Code	MISURE SIZE	Ø	FORI HOLES	ZANCA FOLD	Pcs	VN	VG	ZB
A900ZF1...	167 + 39	10	3 + 1	ZA=21	12			
A900ZF2...	167 + 110	10	3 + 2	ZA=21	12			
A900ZF3...	167 + 185	10	3 + 3	ZA=21	12			
A900ZF4...	167 + 256	10	3 + 4	ZA=21	12			
A900ZF5...	167 + 331	10	3 + 5	ZA=21	12			
A900ZF6...	167 + 402	10	3 + 6	ZA=21	12			
A900ZF7...	167 + 477	10	3 + 7	ZA=21	12			
A900ZF8...	167 + 548	10	3 + 8	ZA=21	12			
A900ZF9...	167 + 623	10	3 + 9	ZA=21	12			

ART. A905

ASENERE «serie Alphacan»
TWIN HINGE «series Alphacan»

CODICE Code	MISURE SIZE	FORI HOLES	Pcs	VN	VG	ZB
A9052...	110 + 110	2 + 2	12			
A9053...	185 + 185	3 + 3	12			
A9054...	256 + 256	4 + 4	12			

ART. A920D

BANDELLA DIRITTA OCCHIO LATERALE «serie Alphacan»
STRAIGHT HINGE WITH OFF-CENTRE EYE «series Alphacan»

CODICE Code	LUNGHEZZA LENGTH	Ø	FORI HOLES	Pcs	VN	VG	ZB
A920D2...	103	10	2	12			
A920D3...	178	10	3	12			
A920D4...	249	10	4	12			
A920D5...	324	10	5	12			
A920D6...	395	10	6	12			
A920D7...	470	10	7	12			

ART. A920SB

BANDELLA DIRITTA OCCHIO CENTRALE A SBALZO «serie Alphacan»
STRAIGHT HINGE WITH CENTRAL EYE AND EMBOSSMENT «series Alphacan»

CODICE Code	LUNGHEZZA LENGTH	Ø	FORI HOLES	Pcs	VN	VG	ZB
A920SB3...	224	10	3	12			
A920SB4...	295	10	4	12			
A920SB5...	370	10	5	12			
A920SB6...	441	10	6	12			
A920SB7...	516	10	7	12			

ART. A920ZA

BANDELLA ZANCATA «serie Alphacan»
STRAIGHT HINGE 90° BENT «series Alphacan»

CODICE Code	LUNGHEZZA LENGTH	Ø	FORI HOLES	ZANCA FOLD	Pcs	VN	VG	ZB
A920ZA5...	324	10	5	ZA=45	12			
A920ZA6...	395	10	6	ZA=45	12			
A920ZA7...	470	10	7	ZA=45	12			
A920ZA8...	541	10	8	ZA=45	12			

ART. A920ZF

BANDELLA ZANCA A FILO «serie Alphacan»
STRAIGHT HINGE 45° BENT «series Alphacan»

CODICE Code	LUNGHEZZA LENGTH	Ø	FORI HOLES	ZANCA FOLD	Pcs	VN	VG	ZB
A920ZF3...	206	10	3	ZA=21	12			
A920ZF4...	277	10	4	ZA=21	12			
A920ZF5...	352	10	5	ZA=21	12			
A920ZF6...	423	10	6	ZA=21	12			
A920ZF7...	498	10	7	ZA=21	12			

ART. E900

BANDELLA SNODATA OCCHIO LATERALE «serie Edil»
DOUBLE HINGE Ø 10 WITH OFF-CENTRE EYE series Edil»

CODICE Code	MISURE SIZE	Ø	FORI HOLES	Pcs	VN	VG	ZB
E9001...	139 + 39	10	3 + 1	12			
E9002...	139 + 110	10	3 + 2	12			
E9003...	139 + 185	10	3 + 3	12			
E9004...	139 + 256	10	3 + 4	12			
E9005...	139 + 331	10	3 + 5	12			
E9006...	139 + 402	10	3 + 6	12			
E9007...	139 + 477	10	3 + 7	12			
E9008...	139 + 548	10	3 + 8	12			
E9009...	139 + 623	10	3 + 9	12			

ART. E900ZF

BANDELLA SNODATA ZANCA A FILO «serie Edil»
DOUBLE HINGE Ø 10 45° BENT series Edil»

CODICE Code	MISURE SIZE	Ø	FORI HOLES	ZANZA FOLD	Pcs	VN	VG	ZB
E900ZF1...	167 + 39	10	3 + 1	ZA=21	12			
E900ZF2...	167 + 110	10	3 + 2	ZA=21	12			
E900ZF3...	167 + 185	10	3 + 3	ZA=21	12			
E900ZF4...	167 + 256	10	3 + 4	ZA=21	12			
E900ZF5...	167 + 331	10	3 + 5	ZA=21	12			
E900ZF6...	167 + 402	10	3 + 6	ZA=21	12			
E900ZF7...	167 + 477	10	3 + 7	ZA=21	12			
E900ZF8...	167 + 548	10	3 + 8	ZA=21	12			
E900ZF9...	167 + 623	10	3 + 9	ZA=21	12			

ART. E905

ASENERE «serie Edil»
TWIN HINGE series Edil»

CODICE Code	MISURE SIZE	FORI HOLES	Pcs	VN	VG	ZB
E9052...	110 + 110	2 + 2	12			
E9053...	185 + 185	3 + 3	12			
E9054...	256 + 256	4 + 4	12			

ART. E920D

BANDELLA DIRITTA OCCHIO LATERALE «serie Edil»
STRAIGHT HINGE WITH OFF-CENTRE EYE «series Edil»

CODICE Code	LUNGHEZZA LENGTH	Ø	FORI HOLES	Pcs	VN	VG	ZB
E920D2...	103	10	2	12			
E920D3...	178	10	3	12			
E920D4...	249	10	4	12			
E920D5...	324	10	5	12			
E920D6...	395	10	6	12			
E920D7...	470	10	7	12			

ART. E920SB

BANDELLA DIRITTA OCCHIO CENTRALE A SBALZO «serie Edil»
STRAIGHT HINGE WITH CENTRAL EYE AND EMBOSSMENT «series Edil»

CODICE Code	LUNGHEZZA LENGTH	Ø	FORI HOLES	Pcs	VN	VG	ZB
E920SB3...	224	10	3	12			
E920SB4...	295	10	4	12			
E920SB5...	370	10	5	12			
E920SB6...	441	10	6	12			
E920SB7...	516	10	7	12			

ART. R9000

BANDELLA SNODATA OCCHIO LATERALE «serie Rehau»
DOUBLE HINGE Ø 10 WITH OFF-CENTRE EYE «series Rehau»

CODICE Code	MISURE SIZE	Ø	FORI HOLES	Pcs	VN	VG	ZB
R9001...	139 + 38	10	3 + 1	12			
R9002...	139 + 111	10	3 + 2	12			
R9003...	139 + 185	10	3 + 3	12			
R9004...	139 + 258	10	3 + 4	12			
R9005...	139 + 332	10	3 + 5	12			
R9006...	139 + 405	10	3 + 6	12			
R9007...	139 + 479	10	3 + 7	12			
R9008...	139 + 552	10	3 + 8	12			

ART. R900ZF

BANDELLA SNODATA ZANCA A FILO «serie Rehau»
DOUBLE HINGE Ø 10 45° BENT «series Rehau»

CODICE Code	MISURE SIZE	Ø	FORI HOLES	ZANCA FOLD	Pcs	VN	VG	ZB
R900ZF1...	167 + 38	10	3 + 1	ZA=21	12			
R900ZF2...	167 + 111	10	3 + 2	ZA=21	12			
R900ZF3...	167 + 185	10	3 + 3	ZA=21	12			
R900ZF4...	167 + 258	10	3 + 4	ZA=21	12			
R900ZF5...	167 + 332	10	3 + 5	ZA=21	12			
R900ZF6...	167 + 405	10	3 + 6	ZA=21	12			
R900ZF7...	167 + 479	10	3 + 7	ZA=21	12			
R900ZF8...	167 + 552	10	3 + 8	ZA=21	12			

ART. R905

ASENERE «serie Rehau»
TWIN HINGE «series Rehau»

CODICE Code	MISURE SIZE	FORI HOLES	Pcs	VN	VG	ZB
R9053...	185 + 185	3 + 3	12			
R9054...	258 + 258	4 + 4	12			

ART. R920D

BANDELLA DRITTA OCCHIO LATERALE «serie Rehau»
STRAIGHT HINGE WITH OFF-CENTRE EYE «series Rehau»

CODICE Code	LUNGHEZZA LENGTH	Ø	FORI HOLES	Pcs	VN	VG	ZB
R920D2...	103	10	2	12			
R920D3...	177	10	3	12			
R920D4...	250	10	4	12			
R920D5...	324	10	5	12			
R920D6...	397	10	6	12			
R920D7...	471	10	7	12			

ART. R920SB

BANDELLA DRITTA OCCHIO CENTRALE A SBALZO «serie Rehau»
STRAIGHT HINGE WITH CENTRAL EYE AND EMBOSSEMENT «series Rehau»

CODICE Code	LUNGHEZZA LENGTH	Ø	FORI HOLES	Pcs	VN	VG	ZB
R920SB3...	224	10	3	12			
R920SB4...	297	10	4	12			
R920SB5...	371	10	5	12			
R920SB6...	444	10	6	12			
R920SB7...	518	10	7	12			

ART. V900

BANDELLA SNODATA OCCHIO LATERALE «serie Veka»
DOUBLE HINGE Ø 10 WITH OFF-CENTRE EYE «series Veka»

CODICE Code	MISURE SIZE	Ø	FORI HOLES	Pcs	VN	VG	ZB
V9001...	137 + 35	10	3 + 1	12			
V9002...	137 + 105	10	3 + 2	12			
V9003...	137 + 185	10	3 + 3	12			
V9004...	137 + 255	10	3 + 4	12			
V9005...	137 + 335	10	3 + 5	12			
V9006...	137 + 405	10	3 + 6	12			
V9007...	137 + 485	10	3 + 7	12			
V9008...	137 + 555	10	3 + 8	12			
V9009...	137 + 635	10	3 + 9	12			

ART. V900ZF

BANDELLA SNODATA ZANCA A FILO «serie Veka»
DOUBLE HINGE Ø 10 45° BENT «series Veka»

CODICE Code	LUNGHEZZA LENGTH	Ø	FORI HOLES	ZANCA FOLD	Pcs	VN	VG	ZB
V900ZF1...	165 + 35	10	3 + 1	ZA=21	12			
V900ZF2...	165 + 105	10	3 + 2	ZA=21	12			
V900ZF3...	165 + 185	10	3 + 3	ZA=21	12			
V900ZF4...	165 + 255	10	3 + 4	ZA=21	12			
V900ZF5...	165 + 335	10	3 + 5	ZA=21	12			
V900ZF6...	165 + 405	10	3 + 6	ZA=21	12			
V900ZF7...	165 + 485	10	3 + 7	ZA=21	12			
V900ZF8...	165 + 555	10	3 + 8	ZA=21	12			
V900ZF9...	165 + 635	10	3 + 9	ZA=21	12			

ART. V905

ASENERE «serie Veka»
TWIN HINGE «series Veka»

CODICE Code	MISURE SIZE	FORI HOLES	Pcs	VN	VG	ZB
V9052...	105 + 105	2 + 2	12			
V9053...	185 + 185	3 + 3	12			
V9054...	255 + 255	4 + 4	12			

ART. V920D

BANDELLA DRITTA OCCHIO LATERALE «serie Veka»
STRAIGHT HINGE WITH OFF-CENTRE EYE «series Veka»

CODICE Code	LUNGHEZZA LENGTH	Ø	FORI HOLES	Pcs	VN	VG	ZB
V920D3...	172	10	3	12			
V920D4...	242	10	4	12			
V920D5...	322	10	5	12			
V920D6...	392	10	6	12			
V920D7...	472	10	7	12			

ART. V920SB

BANDELLA DRITTA OCCHIO CENTRALE A SBALZO «serie Veka»
STRAIGHT HINGE WITH CENTRAL EYE AND EMBOSSMENT «series Veka»

CODICE Code	LUNGHEZZA LENGTH	Ø	FORI HOLES	Pcs	VN	VG	ZB
V920SB3...	220	10	3	12			
V920SB4...	290	10	4	12			
V920SB5...	370	10	5	12			
V920SB6...	440	10	6	12			
V920SB7...	520	10	7	12			

ART. 714 |

CERNIERA TIPO ANUBA Ø 14
ANUBA STYLE HINGE Ø 14

CODICE Code	MISURE SIZE	ALTEZZA HEIGHT	Ø	Pcs	€
714VN	8,2 X 40	50	14	50	
714VG	8,2 X 40	50	14	50	
714ZB	8,2 X 40	50	14	200	

ART. 716 |

CERNIERA TIPO ANUBA Ø 16
ANUBA STYLE HINGE Ø 16

CODICE Code	MISURE SIZE	ALTEZZA HEIGHT	Ø	Pcs	€
716VN	8,7 X 44/50	55	16	50	
716VG	8,7 X 44/50	55	16	50	
716ZB	8,7 X 44/50	55	16	100	

ART. 714LG |

CERNIERA TIPO ANUBA TONDA LUNGA Ø 14
ANUBA STYLE HINGE LONG Ø 14

CODICE Code	MISURE SIZE	ALTEZZA HEIGHT	Ø	Pcs	€
714LGVN	8,2 X 40	82	14	50	
714LGVG	8,2 X 40	82	14	50	
714LGZB	8,2 X 40	82	14	50	

ART. 716LG |

CERNIERA TIPO ANUBA TONDA LUNGA Ø 16
ANUBA STYLE HINGE LONG Ø 16

CODICE Code	MISURE SIZE	ALTEZZA HEIGHT	Ø	Pcs	€
716LGVN	8,7 X 44/50	82	16	30	
716LGVG	8,7 X 44/50	82	16	30	
716LGZB	8,7 X 44/50	82	16	50	

ART. 724 |

CERNIERA GIULIA FORI SVASATI
HINGE GIULIA COUNTERSUNK HOLES

CODICE Code	LUNGHEZZA LENGTH	INTERASSE DISTANCE	MISURE SIZE	Pcs	€
724DXVN	80	I =34	Ø14 X 50	24	
724SXVN	80	I =34	Ø14 X 50	24	
724DXVG	80	I =34	Ø14 X 50	24	
724SXVG	80	I =34	Ø14 X 50	24	
724DXZB	80	I =34	Ø14 X 50	24	
724SXZB	80	I =34	Ø14 X 50	24	

ART. 726 |

CERNIERA GIULIA LUNGA FORI SVASATI
HINGE GIULIA LONG COUNTERSUNK HOLES

CODICE Code	LUNGHEZZA LENGTH	INTERASSE DISTANCE	MISURE SIZE	Pcs	€
726DXVN	80	I =34	Ø14 X 82	24	
726SXVN	80	I =34	Ø14 X 82	24	
726DXVG	80	I =34	Ø14 X 82	24	
726SXVG	80	I =34	Ø14 X 82	24	
726DXZB	80	I =34	Ø14 X 82	24	
726SXZB	80	I =34	Ø14 X 82	24	

59

CERNIERE LEGNO • HINGES FOR WOOD

ART. 30GR

CARDINE A VITE CON GRANO Ø 10
SCREW-IN PIVOT REMOVIBLE PIN Ø 10 WITH HOLE FOR SOCKET HEAD SCREW

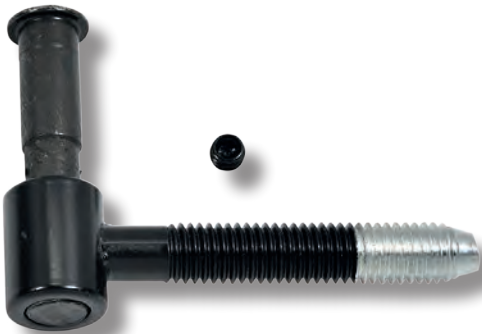

CODICE Code	MISURE SIZE	ALTEZZA HEIGHT	Ø	Pcs	€
30GRVN	60 X M10	20	10	50	
30GRVG	60 X M10	20	10	50	
30GRZB	60 X M10	20	10	50	

ART. 31GR

CARDINE A MURO CON GRANO Ø 10
SCREW-IN PIVOT REMOVIBLE PIN Ø 10 WITH DOWEL

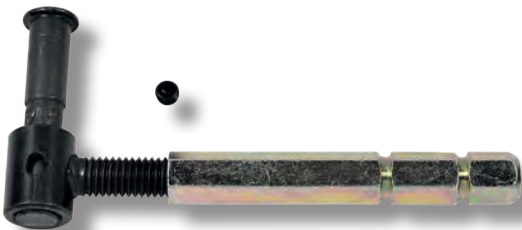

CODICE Code	MISURE SIZE	ALTEZZA HEIGHT	Ø	Pcs	€
31GRVN	30 X M10	20	10	24	
31GRVG	30 X M10	20	10	24	
31GRZB	30 X M10	20	10	24	

ART . TF80 TASSELLO FILETTATO COMPRESO ◆ DOWEL INCLUDE

ART. 32SF

CARDINE A VITE SPINA FISSA Ø 12
SCREW-IN PIVOT Ø 12



CODICE Code	MISURE SIZE	ALTEZZA HEIGHT	Ø	Pcs	€
32SF7VN	70 X M12	30	12	40	
32SF9VN	90 X M12	30	12	40	
32SF7VG	70 X M12	30	12	40	
32SF9VG	90 X M12	30	12	40	
32SF7ZB	70 X M12	30	12	40	
32SF9ZB	90 X M12	30	12	40	

ART. 32SL

CARDINE A VITE SPINA A LEVARE Ø 12
SCREW-IN PIVOT REMOVIBLE PIN Ø 12

CODICE Code	MISURE SIZE	ALTEZZA HEIGHT	Ø	Pcs	€
32SL9VN	90 X M12	30	12	40	
32SL12VN	120 X M12	30	12	30	
32SL9VG	90 X M12	30	12	40	
32SL12VG	120 X M12	30	12	30	
32SL9ZB	90 X M12	30	12	40	
32SL12ZB	120 X M12	30	12	30	

ART. 33

CARDINE A VITE SPINA A LEVARE Ø 10
SCREW-IN PIVOT REMOVIBLE PIN Ø 10

CODICE Code	MISURE SIZE	ALTEZZA HEIGHT	Ø	Pcs	€
33VN	60 X M10	30	10	50	
33VG	60 X M10	30	10	50	
33ZB	60 X M10	30	10	50	

ART. 33GR

CARDINE A VITE SPINA A LEVARE CON GRANO Ø 10
SCREW-IN PIVOT REMOVIBLE PIN Ø 10 WITH HOLE FOR SOCKET HEAD SCRE

CODICE Code	MISURE SIZE	ALTEZZA HEIGHT	Ø	Pcs	€
33GRVN	60 X M10	30	10	50	
33GRVG	60 X M10	30	10	50	
33GRZB	60 X M10	30	10	50	

61

CARDINI • PIVOTS

ART. 33LG

CARDINE A VITE SPINA A LEVARE LUNGO Ø 10
SCREW-IN LONG PIVOT REMOVIBLE PIN Ø 10

CODICE Code	MISURE SIZE	ALTEZZA HEIGHT	Ø	Pcs	€
33LGVN	90 X M10	30	10	50	
33LGVG	90 X M10	30	10	50	
33LGZB	90 X M10	30	10	50	

ART. 33LGGR

CARDINE A VITE SPINA A LEVARE LUNGO CON GRANO Ø 10
SCREW-IN LONG PIVOT REMOVIBLE PIN Ø 10 WITH HOLE FOR SOCKET HEAD SCREW

CODICE Code	MISURE SIZE	ALTEZZA HEIGHT	Ø	Pcs	€
33LGGRVN	90 X M10	30	10	50	
33LGGRVG	90 X M10	30	10	50	
33LGGRZB	90 X M10	30	10	50	

ART. 34

CARDINE A VITE PER MONOBLOCCO Ø 10
EN BLOC SCREW-IN PIVOT Ø 10 WITH CAP

CODICE Code	MISURE SIZE	ALTEZZA HEIGHT	Ø	Pcs	€
34VN	60 X M10	30	10	24	
34VG	60 X M10	30	10	24	
34ZB	60 X M10	30	10	24	

ART. 34LG

CARDINE A VITE PER MONOBLOCCO LUNGO Ø 10
EN BLOC SCREW-IN LONG PIVOT Ø 10 WITH CAP



CODICE Code	MISURE SIZE	ALTEZZA HEIGHT	Ø	Pcs	€
34LGVN	90 X M10	30	10	24	
34LGVG	90 X M10	30	10	24	
34LGZB	90 X M10	30	10	24	

ART. 37GR10

CARDINE A MURO SPINA A LEVARE CON GRANO Ø 10
WALL PIVOT REMOVIBLE PIN Ø 10 WITH HOLE FOR SOCKET HEAD SCREW AND DOWEL



CODICE Code	MISURE SIZE	ALTEZZA HEIGHT	Ø	Pcs	€
37GR10VN	30 X M10	30	10	24	
37GR10VG	30 X M10	30	10	24	
37GR10ZB	30 X M10	30	10	24	

ART . TF80 TASSELLO FILETTATO COMPRESO ◆ DOWEL INCLUDE

ART. 37GR12

CARDINE A MURO SPINA A LEVARE CON GRANO Ø 12
WALL PIVOT REMOVIBLE PIN Ø 12 WITH HOLE FOR SOCKET HEAD SCREW AND DOWEL



CODICE Code	MISURE SIZE	ALTEZZA HEIGHT	Ø	Pcs	€
37GR12VN	30 X M10	30	12	24	
37GR12VG	30 X M10	30	12	24	
37GR12ZB	30 X M10	30	12	24	

ART . TF80 TASSELLO FILETTATO COMPRESO ◆ DOWEL INCLUDE

ART. 38

CARDINE A VITE HERCULES CON GRANO Ø 10
SCREW-IN PIVOT HERCULES REMOVIBLE PIN Ø 10



CODICE Code	MISURE SIZE	ALTEZZA HEIGHT	Ø	Pcs	€
38VN	60 X M10	30 + 30	10	12	
38VG	60 X M10	30 + 30	10	12	
38ZB	60 X M10	30 + 30	10	12	
38LGVN	90 X M10	30 + 30	10	12	
38LGVG	90 X M10	30 + 30	10	12	
38LGZB	90 X M10	30 + 30	10	12	

ART. 50

CARDINE SU LAMA Ø 10
PLATE MOUNTED PIVOT Ø 10



CODICE Code	MISURE SIZE	ALTEZZA HEIGHT	Ø	Pcs	€
50VN	22 X 160	l = 21	10	24	
50VG	22 X 160	l = 21	10	24	
50ZB	22 X 160	l = 21	10	24	

ART. 52

CARDINE SU LAMA Ø 12
PLATE MOUNTED PIVOT Ø 12



CODICE Code	MISURE SIZE	ALTEZZA HEIGHT	Ø	Pcs	€
52VN	28 X 160	l = 24	12	24	
52VG	28 X 160	l = 24	12	24	
52ZB	28 X 160	l = 24	12	24	

ART. 53

CARDINI SU LAMA REGOLABILI Ø 12
 PLATE MOUNTED PIVOT Ø 12 ADJUSTABLE



CODICE Code	MISURE SIZE	ALTEZZA HEIGHT	Ø	Pcs	€
53VN	28 x 160	20 - 75	12	24	
53VG	28 x 160	20 - 75	12	24	
53ZB	28 x 160	20 - 75	12	24	

ART. 94GR

CARDINE A VITE SPINA A LEVARE CON GRANO Ø 10
 SCREW-IN PIVOT REMOVIBLE PIN Ø 10 WITH HOLE FOR SOCKET HEAD SCREW

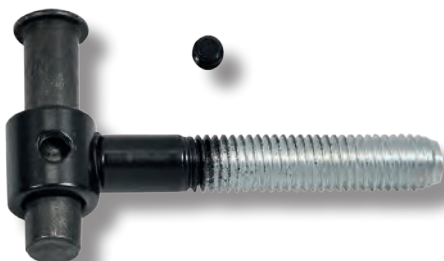

CODICE Code	MISURE SIZE	ALTEZZA HEIGHT	Ø	Pcs	€
94GRVN	60 x M10	15	10	50	
94GRVG	60 x M10	15	10	50	
94GRZB	60 x M10	15	10	50	

ART. 95GR

CARDINE A VITE SPINA A LEVARE CON GRANO Ø 8 PER PADOVANA
 SCREW-IN PIVOT REMOVIBLE PIN Ø 8 WITH HOLE FOR SOCKET HEAD SCREW FOR PADOVA TYPE HINGE

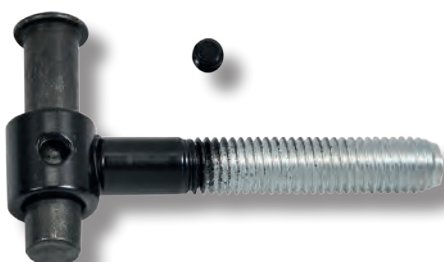

CODICE Code	MISURE SIZE	ALTEZZA HEIGHT	Ø	Pcs	€
95GRVN	60 x M10	14	8	24	
95GRVG	60 x M10	14	8	24	
95GRZB	60 x M10	14	8	24	

ART. 350 |

CATENACCI VERTICALI
VERTICAL LOCKING BOLTS

CODICE Code	LUNGHEZZA LENGTH	MISURE SIZE	Pcs	VN	VG	ZB
35020...	200	43 X h41	6			
35025...	250	43 X h41	6			
35030...	300	43 X h41	6			
35040...	400	43 X h41	6			

ART. 350PB |

CATENACCI VERTICALI POMOLO BASSO
VERTICAL LOCKING BOLTS KNOB LOW

CODICE Code	LUNGHEZZA LENGTH	MISURE SIZE	Pcs	VN	VG	ZB
350PB20...	200	43 X h31	6			
350PB25...	250	43 X h31	6			
350PB30...	300	43 X h31	6			
350PB40...	400	43 X h31	6			

ART. 355 |

CATENACCI VERTICALI ZANCATI
VERTICAL LOCKING BOLTS, BENT

CODICE Code	LUNGHEZZA LENGTH	MISURE SIZE	Pcs	VN	VG	ZB
35525...	250	43 X h41	6			
35540...	400	43 X h41	6			

ART. 360

CATENACCI TRASVERSALI HORIZONTAL LOCKING BOLTS



CODICE Code	LUNGHEZZA LENGTH	MISURE SIZE	Pcs	VN	VG	ZB
36030...	300	43 X h41	6			
36035...	350	43 X h41	6			
36040...	400	43 X h41	6			

ART. 380

CATENACCI TRASVERSALI TONDI SU PLACCA HORIZONTAL LOCKING BOLTS ROUND ON PLATE



CODICE Code	LUNGHEZZA LENGTH	MISURE SIZE	Pcs	VN	VG	ZB
38030...	300	43	6			
38035...	350	43	6			
38040...	400	43	6			
38050...	500	43	6			

ART. 390

CATENACCI TRASVERSALI TONDI HORIZONTAL LOCKING BOLTS ROUND



CODICE Code	LUNGHEZZA LENGTH	MISURE SIZE	Pcs	VN	VG	ZB
39030...	300	35 X 55	6			
39035...	350	35 X 55	6			
39040...	400	35 X 55	6			
39050...	500	35 X 55	6			

ART. 650

SPRANGA SAGOMATA
 REMOVABLE BAR WITH SURMOUNT

CODICE Code	LUNGHEZZA LENGTH	ALTEZZA HEIGHT	Pcs	VN	VG	ZB
65060...	600	30	12			
65070...	700	30	12			
65080...	800	30	12			
65090...	900	30	12			
650100...	1000	30	12			
650120...	1200	30	12			

ART. 652S

SPRANGA PENDENTE SAGOMATA
 HANGING BAR WITH SURMOUNT

CODICE Code	LUNGHEZZA LENGTH	ALTEZZA HEIGHT	Pcs	VN	VG	ZB
652S60...	600	30	12			
652S70...	700	30	12			
652S80...	800	30	12			
652S90...	900	30	12			
652S100...	1000	30	12			
652S120...	1200	30	12			

ART. 652D

SPRANGA PENDENTE DRITTA
 HANGING BAR STRAIGHT

CODICE Code	LUNGHEZZA LENGTH	ALTEZZA HEIGHT	Pcs	VN	VG	ZB
652D60...	600	30	12			
652D70...	700	30	12			
652D80...	800	30	12			
652D90...	900	30	12			
652D100...	1000	30	12			
652D120...	1200	30	12			

ART. 400 |

GRUPPO MANIGLIA E ACCESSORI
HANDLE AND FITTING SET FOR ESPAGNOLETTECON SISTEMA RAPIDO DI MONTAGGIO ◆ WHIT RAPID SYSTEM
MOUNTING

CODICE Code	ALTEZZA HEIGHT	INTERASSE DISTANCE	Pcs	€
400VN	18	I=80	20	
400VG	18	I=80	20	

71

SPAGNOLETTE • ESPAGNOLETTES

ART. 400P |

GRUPPO MANIGLIA E ACCESSORI CON PAREGGIATORE
HANDLE AND FITTING SET WITH LEVELLER FOR ESPAGNOLETTECON SISTEMA RAPIDO DI MONTAGGIO ◆ WHIT RAPID SYSTEM
MOUNTING

CODICE Code	ALTEZZA HEIGHT	INTERASSE DISTANCE	Pcs	€
400PDXVN	18	I=80	20	
400PSXVN	18	I=80	20	
400PDXVG	18	I=80	20	
400PSXVG	18	I=80	20	

ART. 410 |

GRUPPO MANIGLIA E ACCESSORI PER MONOANTA
HANDLE AND FITTING SET FOR SINGLE LEAFCON SISTEMA RAPIDO DI MONTAGGIO ◆ WHIT RAPID SYSTEM
MOUNTING

CODICE Code	ALTEZZA HEIGHT	INTERASSE DISTANCE	Pcs	€
410VN	18	I=80	12	
410VG	18	I=80	12	

ART. 460 |

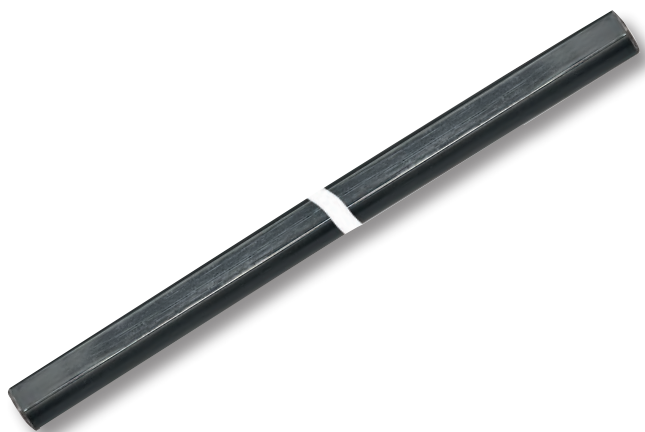
ASTA PER SPAGNOLETTA
ROD FOR ESPAGNOLETTES

CODICE Code	ALTEZZA HEIGHT	Ø ASTA	Pcs	€
46014VN	140	10	20	
46014VG	140	10	20	
46016VN	160	10	20	
46016VG	160	10	20	
46024VN	240	10	20	
46024VG	240	10	20	

ART. 20 |

FERMO PER SPAGNOLETTE
ESPAGNOLETTE LOCK FOR MOUNTING

CODICE Code	MISURE SIZE	ALTEZZA HEIGHT	Pcs	€
20VN	30 X40	16	24	
20VG	30 X 40	16	24	

ART. 21 |

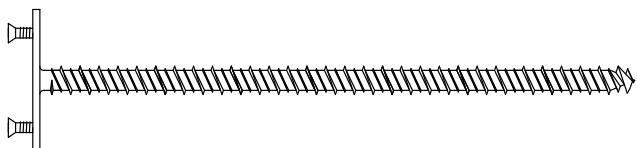
PIASTRINA FISSAGGIO FERMO ZINCATA PER CAPPOTTO
FIXING PLATE GALVANIZED FOR WALL WITH COATING THERMAL

CODICE Code	MISURE SIZE	LUNGHEZZA LENGTH	Pcs	€
2115	30 X40	150	20	
2120	30 X 40	200	20	
2125	30 X 40	250	20	

ART. 80 |

FERMASCURO PER ANTE A PACCHETTO
SHUTTER HOLDER FOR "VICENTINA" TYPE



CODICE Code	INTERASSE DISTANCE	SPESSORE THICKNESS	Pcs	€
80VN	103	15 X 3	20	
80VG	103	15 X 3	20	
80ZB	103	15 X 3	20	

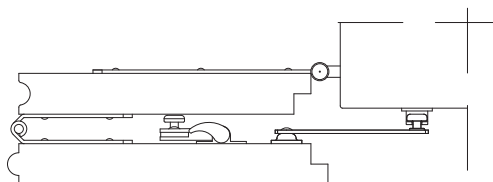

ART. 120 |

FERMASCURO A GANCIO
SHUTTER HOLDER WITH HOOK



CODICE Code	MISURE SIZE	ALTEZZA HEIGHT	Pcs	€
120VN	100X24	19	24	
120ZB	100X24	19	24	

ART. 120C |

FERMASCURO A GANCIO PER CAPPOTTO
SHUTTER HOLDER WITH HOOK FOR WALL WITH COATING THERMAL



CODICE Code	MISURE SIZE	ALTEZZA	VITE SCREW	Pcs	€
120CVN	100X24	30	10X140	16	
120CZB	100X24	30	10X140	16	
120CLVN	100X24	30	10X180	16	
120CLZB	100X24	30	10X180	16	

ART. 125 |

SPESSORE PER FERMASCURO PVC
SHIM FOR SHUTTER HOLDER PVC

CODICE Code	MISURE SIZE	ALTEZZA HEIGH	Pcs	€
125	100X24	5	24	

ART. 126 |

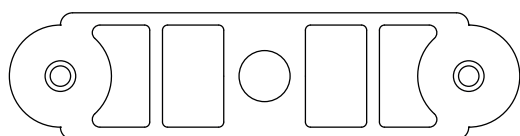
SPESSORE PER FERMASCURO ZAMA
SHIM FOR SHUTTER HOLDER ZAMAK

CODICE Code	MISURE SIZE	ALTEZZA HEIGH	Pcs	€
126VN	100X24	10	50	
126ZB	100X24	10	50	

ART. 130 |

FERMASCURO A SCATTO
AUTOMATIC SHUTTER HOLDER

CODICE Code	MISURE SIZE	ALTEZZA HEIGH	Pcs	€
130VN	100X24	21	24	
130VG	100X24	21	24	
130ZB	100X24	21	24	

ART. 130C |

FERMASCURO A SCATTO PER CAPPOTTO
AUTOMATIC SHUTTER HOLDER FOR WALL WITH COATING THERMAL

CODICE Code	MISURE SIZE	ALTEZZA HEIGH	VITE SCREW	Pcs	€
130CVN	100X24	32	10X140	16	
130CVG	100X24	32	10X140	16	
130CZB	100X24	32	10X140	16	
130CLVN	100X24	32	10X180	16	
130CLVG	100X24	32	10X180	16	
130CLZB	100X24	32	10X180	16	

ART. 140

FERMASCURO MAGNETICO MAGNETIC SHUTTER HOLDER WITH CAP



CODICE Code	MISURE SIZE	ALTEZZA HEIGH	Pcs	€
140N	Ø 40	15 + 15	12	
140G	Ø 40	15 + 15	12	
140B	Ø 40	15 + 15	12	

Disponibile in Nero, Grigio, Bianco.
Available in Black, Grey, White.

1 Pcs = 12 confezioni.
1 Pcs = 12 packages.

Una confezione contiene 2 fermascuri + 1 vite legno 6x40.
A package contains: 2 magnetic shutter complete + 1 screw for wood 6x40.

Fissaggio Fixing



ART. 145

SPESSORE PER FERMASCURO MAGNETICO SHIM FOR MAGNETIC SHUTTER HOLDER



Fissaggio Fixing

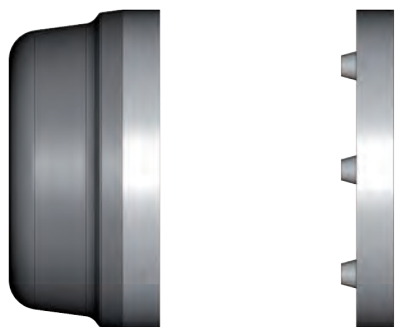

CODICE Code	MISURE SIZE	ALTEZZA HEIGH	Pcs	€
145N	Ø 40	5	24	
145G	Ø 40	5	24	
145B	Ø 40	5	24	

Disponibile in Nero, Grigio, Bianco.
Available in Black, Grey, White.

ART. 45

MANIGLIA STAMPATA
HANDLE

CODICE Code	MISURE SIZE	ALTEZZA HEIGH	Pcs	€
45VN	170	35	50	
45VG	170	35	50	
45ZB	170	35	50	

ART. 48

MANIGLIA STAMPATA
HANDLE

CODICE Code	MISURE SIZE	ALTEZZA HEIGH	Pcs	€
48VN	176	35	50	
48VG	176	35	50	
48ZB	176	35	50	

ART. 60

MANIGLIA SU PLACCA
HANDLE ON PLATE

CODICE Code	MISURE SIZE	ALTEZZA HEIGH	Pcs	€
60VN	157 x 30	37	25	
60VG	157 x 30	37	25	
60ZB	157 x 30	37	25	

ART. 65

MANIGLIA PENDENTE
HANDLE LEANING

CODICE Code	MISURE SIZE	ALTEZZA HEIGH	Pcs	€
65VN	50 x 27	16	25	
65VG	50 x 27	16	25	
65ZB	50 x 27	16	25	

ART. TF |

TASSELLO PER CARDINE A MURO
DOWEL FOR WALL PIVOT



CODICE Code	FILETTO THREAD	LUNGHEZZA LENGTH	Pcs	€
TF80	M10	80	50	
TF130	M10	130	50	
TF160	M10	160	—	
TF200	M10	200	—	
TF250	M10	250	—	

ART. TFP |

TASSELLO FILETTATO IN PVC
DOWEL FOR WALL PIVOT PVC



CODICE Code	FILETTO THREAD	LUNGHEZZA LENGTH	Pcs	€
TFP	M10	80	50	

ART. 7 |

SQUADRETTA ZINCATO PER FISSAGGIO PORTE
BRACKET FOR FIXING DOORS - YELLOW GALVANIZED

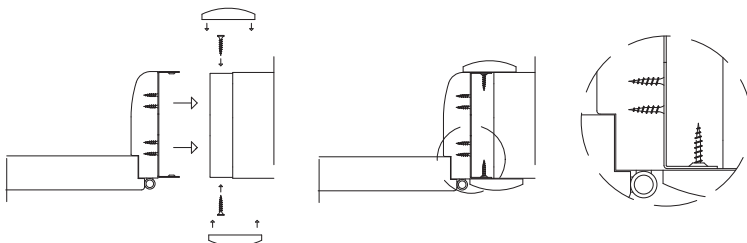
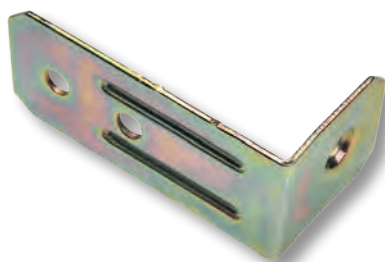

CODICE Code	MISURE SIZE	SPESSORE THICKNESS	Pcs	€
7	55 X 25	1,2	200	

ART. 10 |

ARPIONCINI ZINCATI
NAILS NOTCHED FOR WOOD FRAME



CODICE Code	MISURE SIZE	SPESSORE THICKNESS	Pcs	€
10	55 X 18	1,5	1000	

ART. 12

SQUADRETTA LUNGA PER FISSAGGIO PORTE
LONG BRACKET FOR FIXING DOORS - YELLOW GALVANIZED



CODICE Code	MISURE SIZE	SPESSORE THICKNESS	Pcs	€
12	19 X 100	1,2	200	

ART. 15

ARPIONI cm 9
NAILS NOTCHED TO WALLING FOR WOOD FRAME



CODICE Code	LUNGHEZZA LENGTH	SPESSORE THICKNESS	kg	€
15	90	1,5	25	

ART. 18

SQUADRETTA DRITTA PER FISSAGGIO PORTE
BRACKET FOR FIXING DOORS - YELLOW GALVANIZED

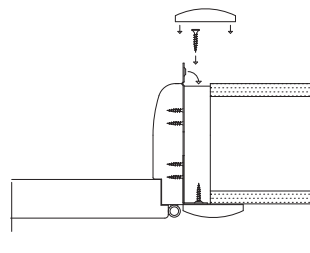

CODICE Code	MISURE SIZE	SPESSORE THICKNESS	Pcs	€
18	55 X 25	1,2	200	

ART. 22

PIASTRINA FILETTATA PER CARDINI
THREADED PLATE FOR PIVOTS



CODICE Code	MISURE SIZE	SPESSORE THICKNESS	FILETTO THREAD	Pcs	€
2210VN	20 X 75	4	M10	100	
2210VG	20 X 75	4	M10	100	
2210ZB	20 X 75	4	M10	100	
2212VN	20 X 75	4	M12	100	
2212VG	20 X 75	4	M12	100	
2212ZB	20 X 75	4	M12	100	

ART. 70 |

SPINA A LEVARE Ø 10
PIN Ø 10



CODICE Code	MISURE SIZE	Ø	Pcs	€
70	70	10	100	

ART. 70LG |

SPINA A LEVARE LUNGHE
LONG PIN Ø 10



CODICE Code	MISURE SIZE	Ø	Pcs	€
70LG	100	10	100	

ART. 72 |

SPINA A LEVARE Ø 12
PIN Ø 12



CODICE Code	MISURE SIZE	Ø	Pcs	€
72	70	12	100	

ART. 75 |

BUSSOLA PER CATENACCI
TUBE FOR LOCKING BOLT

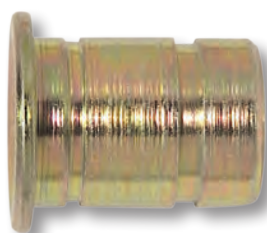

CODICE Code	MISURE SIZE	Ø	Pcs	€
75	20 x Ø14	11	200	

ART. 88

APPENDI GRUCCE
HANG HANGERS

CODICE Code	MISURE SIZE	Ø	Pcs	€
88VN	54 x 27	10	25	
88VG	54 x 27	10	25	
88ZB	54 x 27	10	25	

ART. 99

BRACCETTO A GANCIO REGOLABILE
ADJUSTABLE HOOK

CODICE Code	LUNGHEZZA LENGTH	Ø	Pcs	VN	VG	ZB
9925...	250	8	12			
9930...	300	8	12			
9935...	350	8	12			
9940...	400	8	12			
9945...	450	8	12			
9950...	500	8	12			
9955...	550	8	12			
9960...	600	8	12			

ART. 89

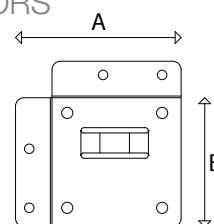
COPPIA ATTACCAGLIE PER CORNICI E SPECCHI
COUPLE HANGERS FOR FRAMES AND MIRRORS

CODICE Code	A	B	ALTEZZA HEIGHT	Pcs	ZB
89	78,5	62,5	11	50 COPPIE 50 PAIRS	

ART. 1000

VITE TESTA CROCE PIANA SVASATA

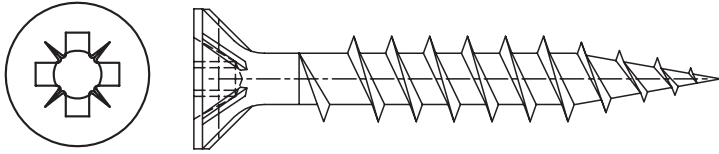

CODICE Code	MISURE SIZE	PCS/CONF	€ 100 PCS
1000VN	4,0X25	1000	
1000VG	4,0X25	1000	

ART. 1001

VITE TESTA CROCE BOMBATA

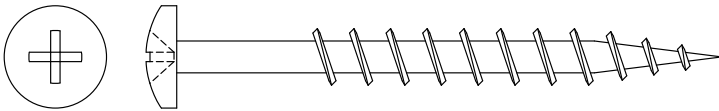

CODICE Code	MISURE SIZE	PCS/CONF	€ 100 PCS
1001VN	4,0X25	1000	
1001VG	4,0X25	500	

ART. 1002

VITE TESTA TORX CON COLLARINO

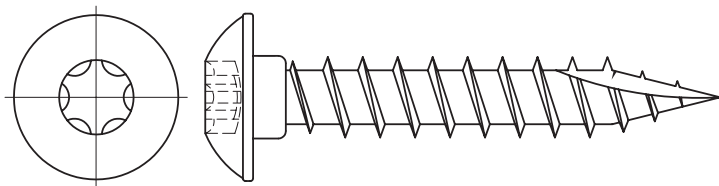

CODICE Code	MISURE SIZE	PCS/CONF	€ 100 PCS
1002VN	5,5X35	500	
1002VG	5,5X35	500	

ART. 1003

VITE TESTA TORX GOCCIA DI SEGO

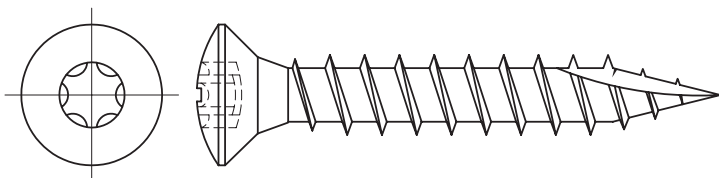

CODICE Code	MISURE SIZE	PCS/CONF	€ 100 PCS
1003VN	5,5X35	500	
1003VG	5,5X35	500	

**ESEMPI DI ZANCATURA
EXAMPLES OF BENDING**



**SERIE TONDA - BANDELLE ZANCA FILO
SERIES TONDA - STRAIGHT HINGE 45° BENT**



**SERIE TONDA - BANDELLE ZANCATE
SERIES TONDA - STRAIGHT HINGE 90° BENT**

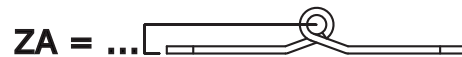

**SERIE TONDA - ASENERE ZANCATE
SERIES TONDA - TWIN HINGE 45° BENT**

**ESEMPI CON INTERASSE
EXAMPLES WITH DISTANCE**

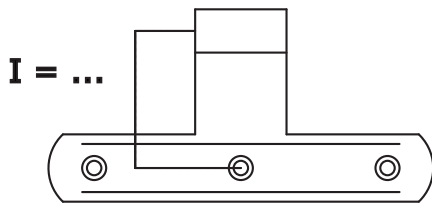

**SERIE TONDA - BANDELLE A " T "
SERIES TONDA - T-SHAPED HINGE**

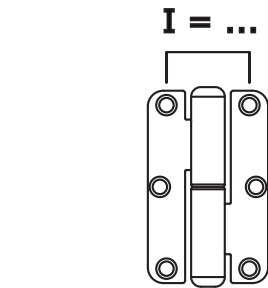
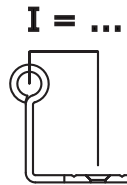

**CERNIERE LEGNO - " GIULIA "
HINGES FOR WOOD - " GIULIA "**

**ESEMPI DI BANDELLE CON SBALZO
EXAMPLE OF STRAIGHT HINGE WITH EMBOSSEMENT**



**SERIE PVC - BANDELLE A SBALZO
SERIES PVC - STRAIGHT HINGE WITH EMBOSSEMENT**



**SERIE TONDA - BANDELLE A " T "
SERIES TONDA - T-SHAPED HINGE**

COME ORDINARE (Esempio)
HOW TO ORDER (Example)

ART. 318

BANDELLA DIRITTA Ø 10 «serie Tonda»
STRAIGHT HINGE Ø 10 «series Tonda»

CODICE Code	LUNGHEZZA Length	SPESSORE Thickness	Ø	Pcs	VN	VG	ZB
3188...	80	38 X 3	10	12			
31810...	100	38 X 3	10	12			
31812...	120	38 X 3	10	12			
31814...	140	38 X 3	10	12			
31816...	160	38 X 3	10	12			
31820...	200	38 X 3	10	12			
31825...	250	38 X 3	10	12			
31830...	300	38 X 3	10	12			
31835...	350	38 X 3	10	12			
31840...	400	38 X 3	10	12			

31820VN

CODICE DA ORDINARE: **31820VN** BANDELLA DRITTA Ø 10
LUNGHEZZA 200 mm VERNICIATA NERA

CODE TO ORDER: **31820VN** STRAIGHT HINGE Ø 10 LENGTH 200 mm
PAINTED BLACK

ART. 110SV

CERNIERA 5x5 FORI SVASATI
DOUBLE HINGE 5 X 5, COUNTERSUNK HOLES

CODICE Code	LUNGHEZZA Length	SPESSORE Thickness	Ø	Pcs	€
110SVVN	50x50	38 x 3	8	24	
110SVVG	50x50	38 x 3	8	24	
110SVZB	50x50	38 x 3	8	24	

CODICE DA ORDINARE: **110SVVG** CERNIERA 5x5 FORI SVASATI
VERNICIATA GRIGIA

CODE TO ORDER: **110SVVG** DOUBLE HINGE 5x5, COUNTERSUNK
HOLES PAINTED GREY

LEGENDA ACRONYM

C	= PER CAPPOTTO - FOR WALL WITH COATING THERMAL	S	= SAGOMATA - WITH SURMONT
D	= DRITTA - STRAIGHT	SB	= CON SBALZO - WITH EMBOSSEMENT
GR	= CON GRANO - WITH HOLE FOR SOCKET HEAD SCREW	SL	= SPINA A LEVARE - PIVOT REMOVIBLE
I	= INTERASSE FORI - DISTANCE HOLE	ST	= STRETTA - NARROW
L	= PER LEGNO - FOR WOOD	SV	= FORI SVASATI - COUNTERSUNK HOLES
LA	= OCCHIO LATERALE - OFF-CENTRE EYE	VG	= VERNICIATO GRIGIO - PAINTED GREY
LG	= LUNGA - LONG	VN	= VERNICIATO NERO - PAINTED BLACK
M	= PER MURO - FOR WALL	Z-ZA	= ZANCATA - 90° BENT
P	= PAREGGIATORE - WITH LEVELLER	Z6	= ZANCA H 60 MM - 90° BENT h 60 mm
PB	= POMOLO BASSO - KNOB LOW	ZB	= ZINCATA BIANCO - WHITE GALVANIZED
		ZF	= ZANCA A FILO - 45° BENT



MATERIALE ACCIAIO DD11 EN 10111
MATERIAL STEEL DD11 EN 10111
TRATTAMENTO DI BASE ZINCATURA
TREATMENT OF BASE GALVANIZED

TRATTAMENTO DI FINITURA VERNICIATURA CON POLVERI DI POLIESTERE SPECIFICHE
FINISHING TREATMENT POLYESTER POWDER COATING FOR EXTERIOR SPECIFICATIONS QUALICOAT
RESISTENZA IN NEBBIA SALINA 600 ORE.
RESISTANCE 600 HOURS SALTY FOG



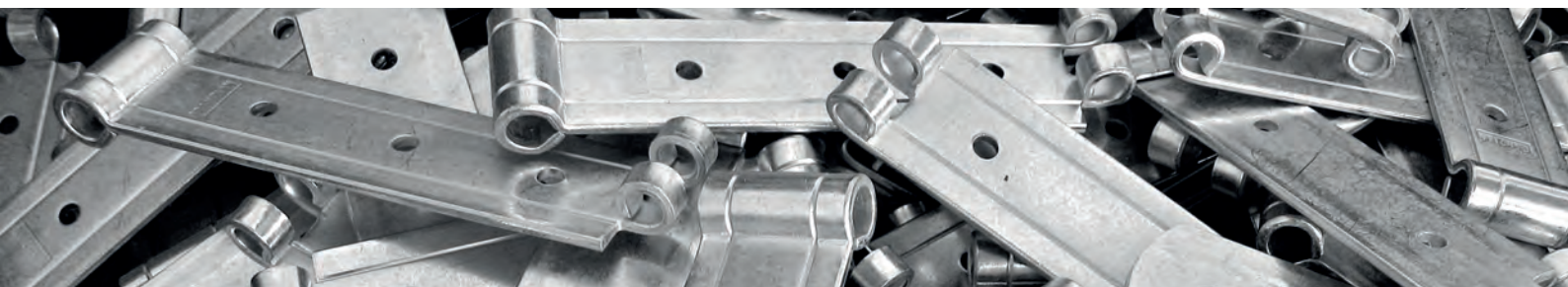

UN RESPONSABILE IN PRODUZIONE CONTROLLA LE VARIE FASI, SEGUENDO UNA CONSOLIDATA PROCEDURA DI AUTOCONTROLLO CON STRUMENTI TRADIZIONALI E TECNOLOGIE DI NUOVA GENERAZIONE. L'APPLICAZIONE DEL CONTROLLO QUALITÀ CONSISTE NELL'ASSICURARSI CHE IL PRODOTTO SIA CONFORME AI REQUISITI ESPRESSI EFFETTUANDO, PRIMA DELLA CONSEGNA, TUTTI I CONTROLLI, LE PROVE E LE MISURAZIONI NECESSARIE PER ELIMINARE QUEI PRODOTTI CHE NON CORRISPONDONO.

RESPONSIBLE FOR PRODUCTION CONTROL IN A DIFFERENT PHASES FOLLOWING STATEMENTS A SELF-TEST PROCEDURE WITH TRADITIONAL TOOLS AND TECHNOLOGIES OF A NEW GENERATION. THE APPLICATION OF QUALITY CONTROL IS TO ENSURE THAT THE PRODUCT MEETS THE REQUIREMENTS EXPRESSED BY CARRYING OUT, BEFORE DELIVERY, ALL CHECKS, TESTS AND MEASUREMENTS NECESSARY TO ELIMINATE THOSE PRODUCTS THAT DO NOT MATCH.

CANZIAN: CONTROLLO QUALITÀ - QUALITY CONTROL



CONDIZIONI GENERALI DI VENDITA

1) GENERALITÀ

La Canzian produce e vende ferramenta per infissi con marchio proprio su tutto il territorio italiano.

I rapporti commerciali tra la Canzian e il cliente sono regolati dalle seguenti condizioni generali di vendita.

L'accettazione, espressa o tacita, costituisce rinuncia da parte del Cliente all'applicazione delle proprie Condizioni di Acquisto, generali e particolari. Qualunque condizione contenuta nell'ordine che modifichi, contrasti o contraddica le presenti condizioni sarà considerata invalida e non applicabile, salvo che le Condizioni stabiliscano diversamente. Eventuali deroghe alle presenti condizioni dovranno essere redatte per iscritto. Il venditore si riserva il diritto insindacabile di modificare in qualsiasi momento le condizioni, dandone espressa comunicazione ai Clienti. L'ordine è inteso come proposta irrevocabile di acquisto, mentre deve ritenersi accettato dal Venditore unicamente a seguito della conferma di ordine o dell'evasione dell'ordine stesso.

2) PROCEDURE D'ORDINE

Tutti gli ordini dovranno essere trasmessi per iscritto e completi in ogni parte necessaria per la corretta individuazione dei Prodotti richiesti. Non verranno accettati ordini telefonici o verbali.

L'acquirente potrà richiedere l'annullamento o la modifica dell'ordine solo prima dell'esecuzione dello stesso, tramite comunicazione scritta.

Il venditore ha la facoltà di non accettare modifiche o annullamenti d'ordine in relazione allo stato di avanzamento della commessa. Le modifiche e l'annullamento, per avere effetto, dovranno essere espressamente accettate dal Venditore.

Gli ordini possono essere inoltrati:

In forma scritta: fax al n. 0438/701867

In forma telematica: tramite mail all'indirizzo commerciale@canzian-tv.it

Minimo d'ordine: 250,00 € (IVA esclusa), salvo diversa pattuizione contrattuale.

3) QUANTITÀ

Si accettano ordini solo per confezioni integre, come riportate sul ns. listino

4) PREZZI E CONDIZIONI DI PAGAMENTO

4.1. Le offerte del Venditore, salvo espressa deroga scritta contenuta nell'offerta stessa, hanno una validità massima di 30 gg dall'emissione dell'offerta. Decorso il termine, l'offerta decadrà automaticamente.

4.2. I prezzi riportati sul listino sono al netto di IVA. Il Venditore ha la facoltà di apportare variazioni ai listini senza alcun preavviso, dandone espressa comunicazione ai Clienti. I prezzi applicati all'ordine saranno quelli in vigore al momento dell'accettazione dell'ordine stesso oppure quelli diversi specificamente concordati in appositi CONTRATTI DI FORNITURA.

4.3 I pagamenti dovranno essere effettuati nei termini stabiliti anche in caso di ritardo nella consegna oppure per perdita totale/parziale della merce non imputabile al Venditore. In caso di pagamenti dilazionati, il mancato pagamento di una sola scadenza comporta l'esigibilità del saldo delle altre scadenze ai sensi dell'art. 1186 c.c..

Per clienti nuovi si richiede il pagamento anticipato tramite bonifico bancario. Assegni, cambiali, tratte e ricevute bancarie si considerano pagamenti effettuati unicamente al relativo buon fine degli stessi.

4.4 In caso di ritardo rispetto ai termini di pagamento convenuti, il Venditore applicherà automaticamente interessi commerciali ai sensi e per gli effetti della legge 231/2002.

4.5 Il Venditore, in caso di ritardo nell'adempimento da parte dell'Acquirente, di elevata esposizione o di diminuzione nell'affidamento (rischio di insolvenza) avrà la facoltà di:

- esigere il pagamento anticipato;
- sospendere del tutto o in parte l'esecuzione degli ordini in corso alla data dell'inadempimento;
- revocare le dilazioni di pagamento convenute, rendendo pertanto immediatamente esigibili tutti i crediti dell'Acquirente.

5) CONSEGNA

5.1 I termini di consegna decorrono dal giorno dell'accettazione dell'ordine da parte del Venditore.

5.2 Il Venditore non è responsabile di eventuali ritardi nella consegna in caso di:

- forza maggiore o evenienze straordinarie, penuria di materie prime, restrizione di fonti energetiche;
- ritardi imputabili all'Acquirente, in particolare per la mancata o tardiva comunicazione di dati indispensabili per l'evasione dell'ordine;
- mancato rispetto delle Condizioni di pagamento, ai sensi degli artt. 1460 e 1461 c.c.

5.3 I ritardi imputabili al Venditore potranno dar luogo ad eventuali risarcimenti unicamente nei CONTRATTI DI FORNITURA siano state espressamente pattuite delle penali, ed in ogni caso fino ad un importo massimo pari al valore della fornitura.

5.4 L'Acquirente deve prendere in consegna le merci anche in caso di consegne parziali o successive alla data convenuta. Saranno a carico dello stesso tutte le spese generate dal mancato ritiro della merce.

5.5 In caso di modifiche all'ordine, che siano state concordate dalle parti ai sensi delle presenti Condizioni di vendita, il termine di consegna verrà automaticamente prorogato del tempo necessario per l'esecuzione dell'ordine così come modificato.

6) RESPONSABILITÀ E DENUNCIA DEI VIZI

6.1 Salvo diverso accordo scritto tra le parti, le merci verranno rese franco magazzino del Venditore. Il Venditore, ai sensi dell'art. 1510 comma 2 c.c., si intende liberato dall'obbligo della consegna con l'affido delle merci al vettore incaricato, pertanto il rischio relativo al trasporto grava sull'Acquirente. In caso di reso porto franco, espressamente concordato tra le parti, sarà cura del Venditore scegliere un corriere di propria fiducia.

6.2 L'Acquirente, al momento della ricezione delle merci, è tenuto alla verifica della qualità/quantità rispetto a quanto indicato nell'ordine. In caso di anomalie/vizi riscontrati immediatamente, potrà non accettare la consegna comunicando immediatamente al Venditore i motivi del rifiuto.

6.3 L'Acquirente deve in ogni caso comunicare per iscritto entro 8 (otto) giorni le non conformità rilevate ed i vizi delle merci. In caso di vizi occulti, il termine di cui sopra decorrerà dalla scoperta del vizio, purché la denuncia avvenga, a pena di decadenza, entro un massimo di 1 (un) anno dalla consegna. Il reclamo dovrà essere formulato per iscritto ed indirizzato al Venditore a mezzo raccomandata. Nel reclamo dovranno essere indicati tutti i Dati necessari per rintracciare la spedizione: numero ordine, ddt, fattura ecc....

Il Venditore, a proprio insindacabile giudizio ed in relazione allo stato e tipologia della merce, potrà:

- fornire la merce mancante in caso di errore sulla quantità;
- riparare/sostituire la merce viziata;
- concedere sconti su future forniture;
- emettere nota di credito e disporre il ritiro della merce.

Qualsiasi reclamo o contestazione oltre i termini espressamente indicati nelle Condizioni Generali di Vendita non verrà preso in considerazione e la merce sarà ritenuta conforme sotto ogni aspetto.

7) GARANZIE

7.1 Il Venditore garantisce che la fornitura è conforme alle specifiche dell'ordine, rispetta norme e regolamenti vigenti, è adatta all'impiego richiesto e priva di difetti tali da renderla inadatta all'uso.

7.2 Il venditore non risponde in caso di manomissione della merce, deterioramento per causa non imputabile al Venditore, utilizzo della merce al di fuori dei limiti di utilizzo consueti o stabiliti da apposite .

7.3. Il non funzionamento del sistema complessivo in cui la merce verrà inserita, non comporterà responsabilità del Venditore, dato che quest'ultimo non effettua montaggio.

8) RISOLUZIONE DEL CONTRATTO

8.1. In caso di mancato pagamento, totale o parziale, o di violazione delle presenti Condizioni Generali di Vendita, il Venditore avrà la facoltà di sospendere la fornitura e le relative garanzie, nonché di risolvere immediatamente il rapporto in corso.

8.2. Il Rapporto fra le Parti si intende inoltre risolto ipso jure in caso di:

- fallimento o altre procedure concorsuali previste dalla legge;
- cessazione di azienda o ramo d'azienda.

9) PRIVACY

9.4. Il Venditore garantisce che le informazioni ed i dati personali ad essa comunicati verranno trattati nel pieno rispetto della Legge Vigente in materia di tutela e trattamento dei dati personali. Presso il Venditore saranno raccolti ed archiviati i dati anagrafici e commerciali relativi al Contratto di Vendita allo scopo di adempiere agli obblighi di legge. In caso di rifiuto a fornire i dati anagrafici e fiscali, il Venditore sarà impossibilitato all'erogazione della fornitura richiesta.

9.5. L'Acquirente può esercitare i diritti di cui all'art. 7 del D.lg. 196/2003. Il titolare responsabile del trattamento dei dati è Canzian, Via Padania, 10/12, 31020 San Vendemiano (TV)

10) GIURISDIZIONE E LEGGE APPLICABILE

10.1 Il Foro competente in via esclusiva per le controversie derivanti dall'interpretazione ed applicazione delle presenti Condizioni è il Foro di Treviso.

10.2 La legge applicabile al rapporto contrattuale è la legge italiana.

GENERAL CONDITIONS OF SALE

1) GENERALITY

Canzian produces and sells ironware for doors and windows with their own brand on the whole Italian territory.

The commercial relations between the Canzian and the client are governed by the following terms and conditions of sale.

The acceptance, express or implied, as a waiver by the client to the application of its Conditions of Purchase, general and particular. Any condition in order to amend, conflict with or contradict these terms and conditions shall be deemed invalid and unenforceable, unless the conditions provide otherwise. Any exceptions to these conditions must be in writing. The seller reserves the right to change the terms at any time, by giving express notice to the Customers. The order is understood as irrevocable offer to purchase, and must be deemed accepted by the Seller only after confirmation of order or evasion of the 'same order.

2) TERMS AND CONDITIONS

All orders must be submitted in writing and complete in every part necessary for the proper identification of products required. We will not accept verbal or telephone orders.

The purchaser may request the cancellation or modification of the order just before the execution of the same, by means of written communication.

The seller has the right to not accept changes or cancellations of orders in relation to the progress of the job. The changes and cancellation, to have effect, must be expressly accepted by the Seller.

Orders can be submitted:

- In writing: Fax no. 0438/701 867

- In electronic form: via email at commerciale@canzian-tv.it

Minimum order: 250,00 € (excluding VAT), unless otherwise agreed in the contract.

3) QUANTITY

We accept orders only for unopened packs, as shown in our pricelist

4) PRICE AND TERMS OF PAYMENT

4.1.A quotation by the Seller, does not constitute an offer and the Seller reserves the right to withdraw or amend the same at any time prior to the Seller's acceptance in writing of the Buyer's order.

4.2.Quotations listed on the price list are net of VAT. The Seller has the right to make changes to the lists without prior notice, by giving express notice to the Customers. The prices applied to the order will be those in effect at the time the order is the same or different ones specifically agreed in special SUPPLY CONTRACTS.

4.3 Payments shall be made in the terms established in the event of delay in delivery or for total loss / part of the goods is not attributable to the Seller. In the case of deferred payments, non-payment of a single maturity involves the enforceability of the balance of the other deadlines pursuant to art. 1186 of the Civil Code.

For new customers we require payment in advance by bank transfer.

Checks, bills, drafts and bank receipts shall be deemed payments made solely to its successful conclusion of the same.

4.4 In case of delay with respect to the payment terms agreed, the Seller will automatically apply commercial interests within the meaning and for the purposes of the law 231/2002.

4.5 The Seller, in the event of delay in performance by the Purchaser or of decrease in entrusting high exposure (risk of default) shall be entitled to:

- Require prepayment;
- Suspend all or part of the execution of orders in progress at the date of default;
- Revoke payment terms agreed, thus making all loans immediately due and payable by the Buyer.

5) DELIVERY

5.1 Date for delivery shall commence from the date of acceptance of the order by the Seller.

5.2 The Seller shall not be liable for any delay in delivery in the event of:

- Force majeure or exceptional occurrences, shortage of raw materials, restriction of energy sources;
- Delays attributable to the Purchaser, in particular for non- or late communication of data required for order fulfillment;
- Failure to observe the terms of payment, in accordance with Articles 1460 and 1461 of the Civil Code

5.3 Delays attributable to the Seller may give rise to any compensation only in the SUPPLY CONTRACTS have been expressly agreed penalties, and in each case up to a maximum amount equal to the value of the supply.

5.4 The Buyer must shall take delivery of the goods in the event of partial deliveries or after the agreed date. Will be charged at the customer all costs incurred by the non- collection of the goods.

5.5 In the event of changes to the order, which have been agreed by the parties pursuant to these Conditions of Sale, the terms of delivery will be automatically extended by the time required for the execution of the order as amended.

6) LIABILITY' AND TERMINATION OF DEFECTS

6.1 Unless otherwise agreed in writing between the parties, the delivery of goods will be at the seller's warehouse.

6.2 The Purchaser, upon receipt of the goods, is required to verify the quality / quantity than specified in the order. In the event of faults / defects found immediately, you can not accept delivery and immediately notify the Seller of the reasons for the refusal.

6.3 The Buyer shall in any event notify in writing within eight (8) days of the non-conformities found and vices of goods. In the case of hidden defects, the above term will run from the discovery of the defect, provided that the report is made, on pain of forfeiture, within a maximum of one (1) year from delivery. The complaint must be made in writing and sent by registered mail to the seller. The complaint will identify all the data necessary to trace the shipment: order number, delivery note, invoice, etc. The Seller shall, at its own discretion and in relation to the state and type of goods,:

- Provide the missing goods in the event of error quantity;
- Repair / replace the defective goods;
- Provide for discounts on future deliveries;
- Issue a credit note and order the withdrawal of the goods.

Any claim or dispute over the terms expressly set forth in the General Conditions of Sale shall not be taken into account and the goods will be deemed to conform in all respects.

7) GUARANTEES

7.1. The Seller warrants that the provision complies with the specifications of the order, complies with rules and regulations, it is suited for the application and free from defects that would render it unfit for use.

7.2 The seller does not respond in the event of tampering with the goods, deterioration due to causes not attributable to the Seller, the use of the goods outside the limits established by the appropriate or customary use.

7.3. The non-functioning of the overall system in which the goods will be inserted, will not result in liability of the Seller, as the latter does not mount parts.

8) TERMINATION OF CONTRACT

8.1. In the event of non-payment, partial or total, or breach of these Terms and Conditions of Sale, the Seller shall be entitled to suspend the provision and related guarantees, as well as to immediately terminate the relationship going.

8.2. The Relationship of the Parties shall also intends resolved ipso jure in the case of:

- Bankruptcy or other insolvency proceedings provided by law;
- Sale of business or line of business.

9) PRIVACY

9.4. The Seller warrants that the information and personal data communicated to it will be treated in full respect of the Governing Law for the protection and processing of personal data. At the Seller will be collected and stored data and trade agreements relating to the Contract of Sale in order to fulfill its legal obligations. In case of refusal to provide personal and fiscal data, the Seller will be unable provision of services required.

9.5. The Purchaser may exercise the rights under Art. 7 of Legislative Decree 196/2003. The party responsible for data processing is Canzian, Via Padania, 10/12, 31020 San Vendemiano (TV)

10) JURISDICTION AND APPLICABLE LAW

10.1 The exclusive place of jurisdiction for disputes arising from the interpretation and application of these Terms and Conditions is the Court of Treviso.

10.2 The law applicable to the contractual relationship is the Italian law.



Italian quality
Italian technology
Italian production

31020 SAN VENDEMIANO [Tv] - Italy - Via Padania 10-12
tel +39 0438 460245 - fax +39 0438 701867
www.canzian-tv.it - info@canzian-tv.it